

INSTRUCTION MANUAL

VT TL 1 Satin/Grey
93490

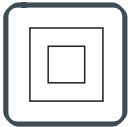

SAFETY DIRECTIONS

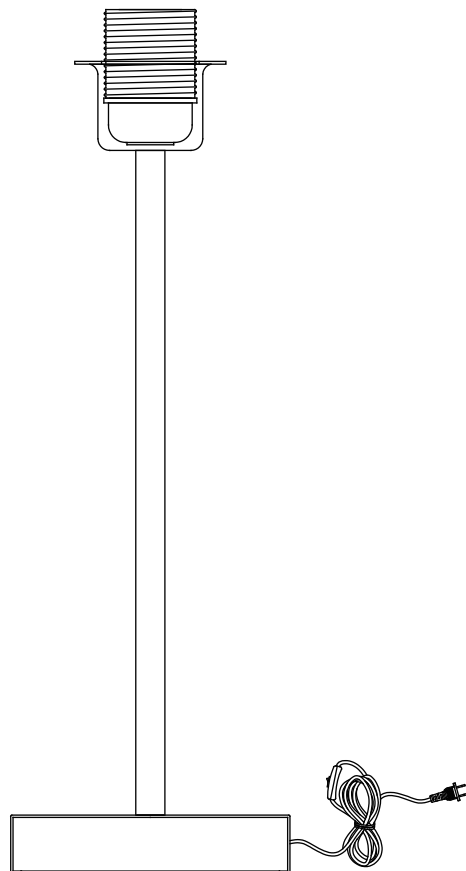
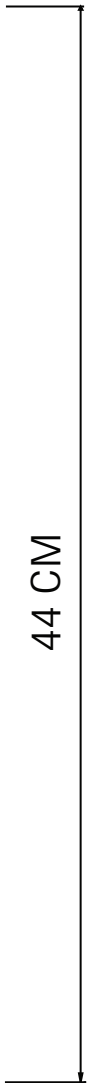
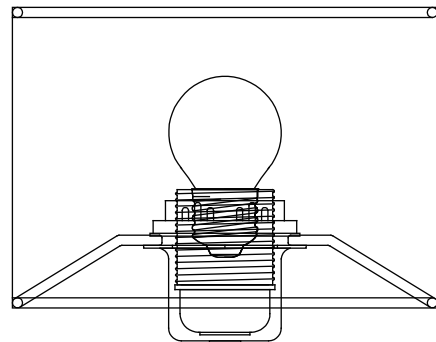
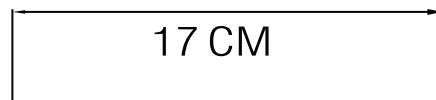
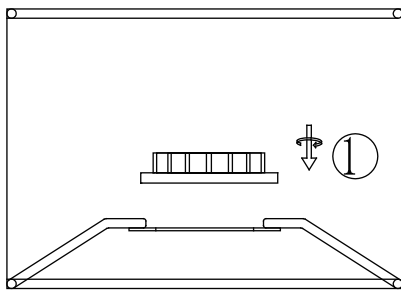
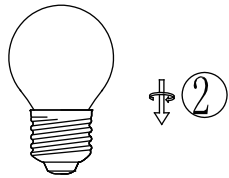

Please study the instruction manual and below information carefully before installing or using this product. Please keep this user manual for further reference

1. The luminaires may only be installed by authorized and qualified technicians according the valid regulations for electrical installation.
2. Maintenance of the luminaires is limited to their surfaces. During maintenance no moisture can come into contact with any areas of the terminal connections or voltage control parts.
3. The electrical supply must be switched off at the outset, preferably by means of a switch in the distribution box, before any installation, maintenance or repair work is undertaken.
4. Exterior lighting must not be installed during rain.
6. Take account of the minimal separation distance from other objects and the room required around the fitting.
7. If in any doubt, consult a professional, taking local installation requirements into account. Some countries stipulate that lighting may be installed only by registered installers.
8. Clamping screws in electrical connections must be adequately tightened. This is particularly the case with 12V low voltage conductors.
9. When replacing a halogen lamp, wait for it to cool, for a minimum of 5 minutes.
10. Clean with a clean, dry cloth or brush, use no solvents or abrasives. Avoid dampness on all electrical components
11. Take account of all available technical information.
12. Take note of the symbols when connecting wires:
N =Neutral
L =Live
⊕ =Earth
13. Meaning of symbols:



For indoor use only, where direct contact with water is impossible



Protection class 1: the fitting must be earthed



Protection class 2: the fitting is double insulated and does not require earthing



Protection class 3: the fitting is low voltage



Observe the indicated minimum distance between the lam and the illuminated materials/objects



Only the self-screening halogen illuminants should be used with the luminaire



Strip the wire to the indicated length



Connect using the specified cable



The armature can be used in combination with a dimmer. Consult the sales outlet for the correct type of dimmer(important in the case of 12V fittings)



Suitable for installing on normal inflammable materials



The maximum wattage indicated in each lighting unit, for example, must not be exceed



This luminaire cannot be disposed together with normal domestic waste in standard rubbish bin, but you have to bring it to a staging area for electrical waste



This luminaire was designed to work only with the indicated voltage