

INSTRUCTION MANUAL

Dents HL 60 Copper 91127

1、 Put the plate to the wall and use the pencil to mark the holes.

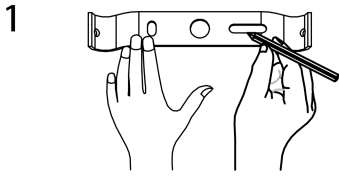

2、 Drill the holes on the wall.

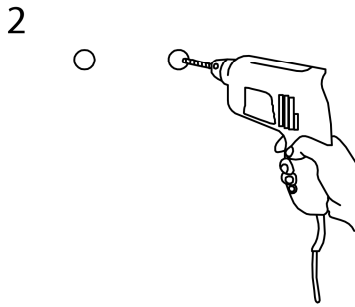

3、 Fix the plate to the wall by screw.

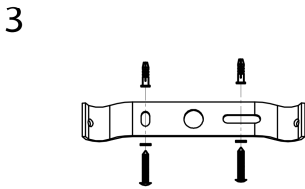

4、 Connect the fixture by positive and negative poles.

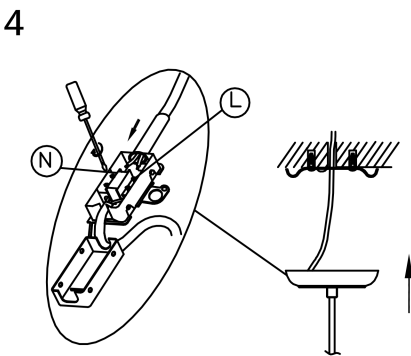

5、 Fix the canopy to the wall by screws.

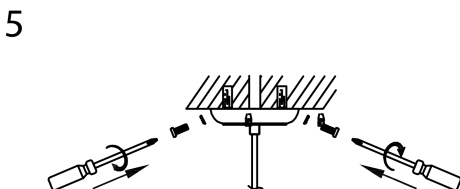

6、 Take out the lamp cup and lampholder ring.

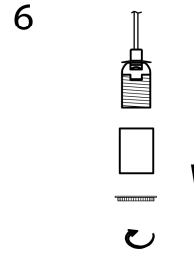

7、 Put the lamp shade and lamp cup into the lampholder then screw the lampholder ring.

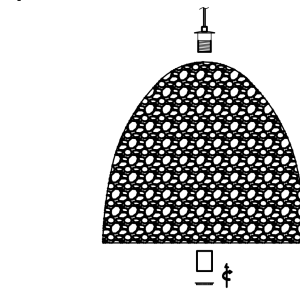

8、 Screw the bulb into the lampholder.

