

Please note the information contained in these instructions and save these manual

TECHNICAL DATA:

HOLDER OUTPUT:- MAX 60 W E27 220-240 V

INSTRUCTIONS FOR USE:-

- 1- THE Lamp is for ceiling purpose only.
- 2- The 3 core wire is used , highly protected and safe.
- 3- The connector with junction box is fixed in the ceiling cup for safety purpose.
- 4- The lamp is with chain and hook for hanging.
- 5- Complete fitting is as per CE European slandered.
- 6- The hanging chain is 1 mtr.
- 7- The lamp finish reflects the interior decoration colors.
- 8- The lamp is completely assembled, there is no need to change any fitting,
- 9- The product parts manual is inserted just for the acknowledgement.

WARNING:-

- 1- Do not put the lamps near the flammable or any explosive product.
- 2- Do not open under the pane by oneself.
- 3- Keep the product clean and clear for good lighting function.
- 4- If the item not works so smoothly please check the bulb holder inside the lamp shade or you can change the bulb only.
- 5- This lamp is only for indoor use.
- 6- The external flexible cable of the lamp can not be replaced, if the cable is damaged, the lamp wiring can be change by professional electrician only.
- 7- Keep away from the reach of children.
- 8- Please keep product untouched and unshakable, it should not be waving while hanging.

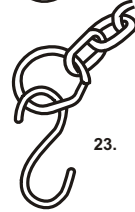







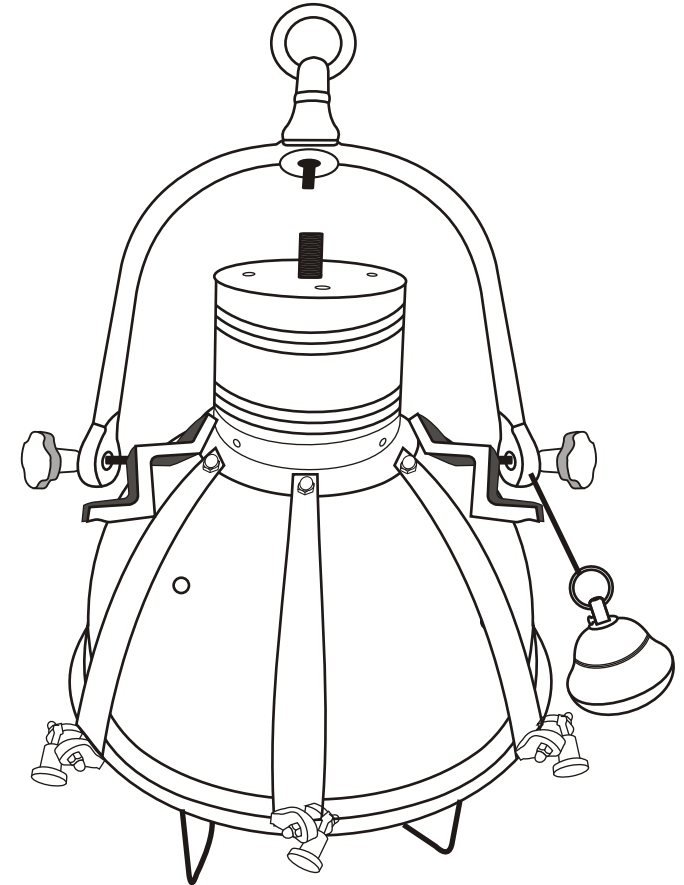







WWW.QAZQA.COM

ITEM # : 90220

DESC. : Raw HL III Chrome



THE MANUAL OF LAMP PARTS

1.  HOLDER HOOK
2.  HANDLE
3.  ALUMINIUM FLOWER GRIP
4.  ALU ROUND CIRCLE
5.  ALU SCREW FIXING PART
6.  ALUMINIUM UPPER CAP OF SHADE
7.  LAMP SHADE
8.  ALUMINIUM RING WITH ROUND FIXING SCREW.
9.  SCREW & SCREW CAP
10.  SCREW ROD & NUT
11.  SHADE ARMS
12.  GLASS
13.  SHADE BELOW RING
14.  NET

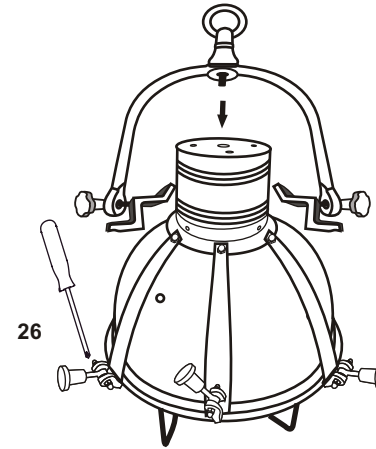

26. Now the shade and aluminium glass ring with net will get tight through round fixing screw.

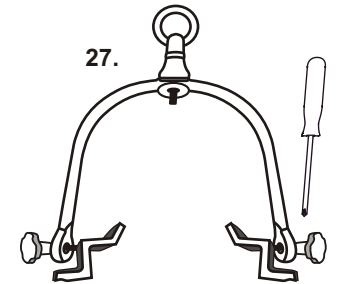

27. Now the handle is ready with all its parts.

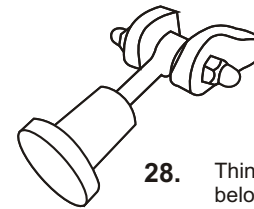

28. This is the round fixing screw in the below round ring of the shade.

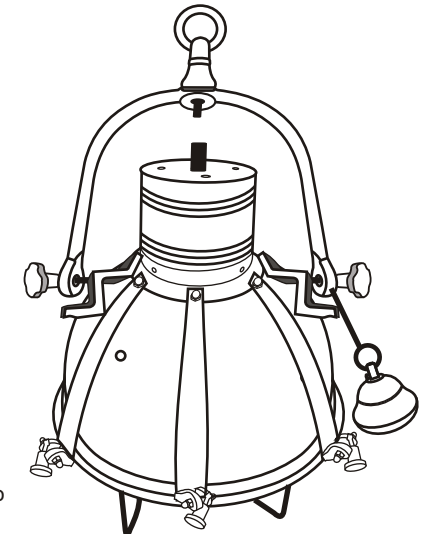

29. Now the glass ring with net is lighted to the shade. now its completed.

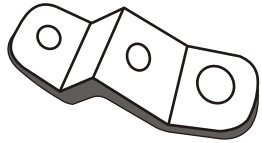

7.

Now the aluminium screw fixing part will be placed inside the ring rod which is coming out from the flower grip. this screw fixing part is very important because it make the handle and shade combine.

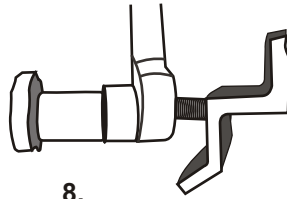

8.

Now the 4 things are combined together with one screw rod .

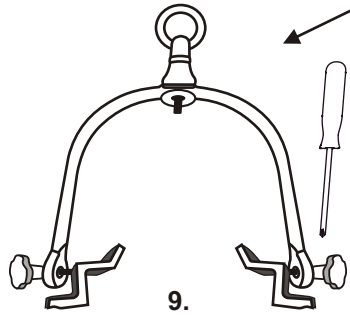

9.

Now the handle is ready with all its ports.

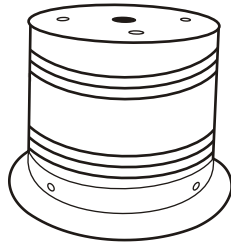

10.

Now the aluminium upper cap will be placed on the shade.

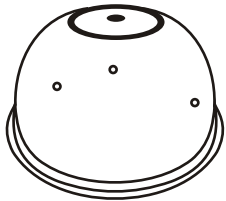

11.

Its the aluminium shade for the fixing the parts.

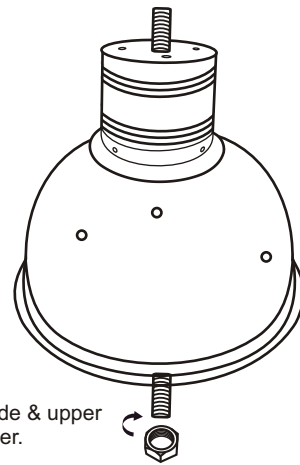

12.

Now the shade & upper cap is together.



13.

The upper cap & shade will be combined by screw & screw cap will be on the upper side of shade screw will be tight from inside.

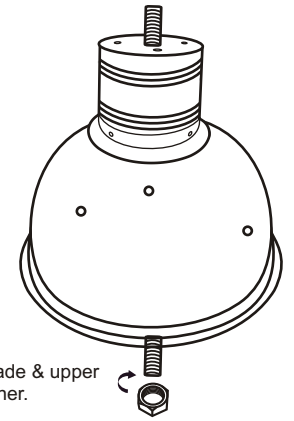

14.

Now the shade & upper cap is together.

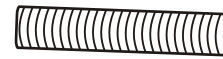

15.

Now screw rod & nut will be fix in the upper cap of shade.

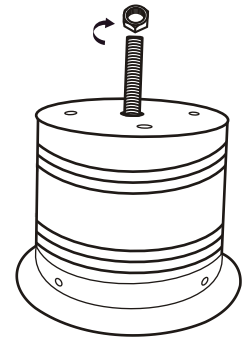

16.

Now the rod is getting fix.

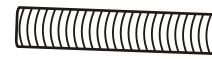

17.

Now screw rod & nut will be fix in the upper cap of shade.

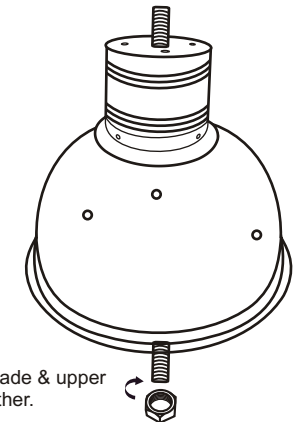

18.

Now the shade & upper cap is together.



19.

These are the shade arms.

MANUAL WITH INSTALLATION DESCRIPTION OF LAMP PARTS



20. The upper cap & shade will be combined by screw & screw cap will be on the upper side of shade screw will be tight from inside.

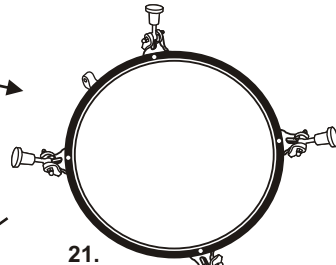

21. The aluminium ring with roundfixing screws will be place from the bottom side of shade.

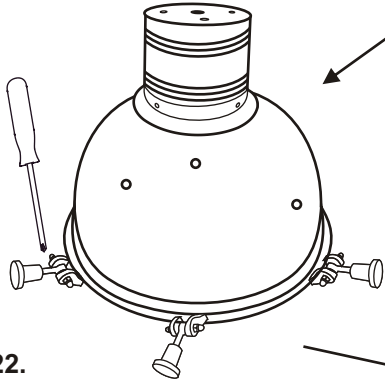

22. Now the shade is with upper shade arms below round ring.

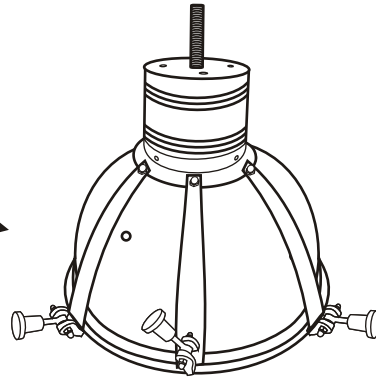

23. Now the shade is completely decorated.

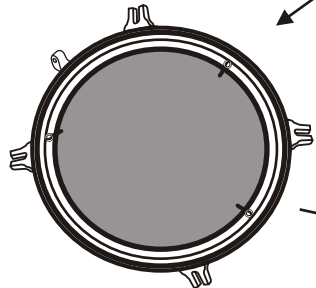

24. The aluminium glass ring will be place by the below of shade lower ring.

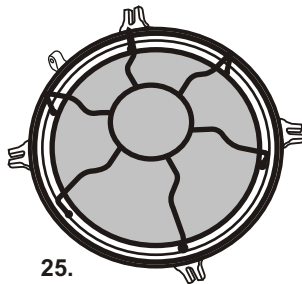

25. Now the aluminium glass ring is with iron net.

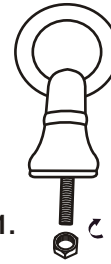

1. The hook holder will be screw in the bottom by a screw rod.

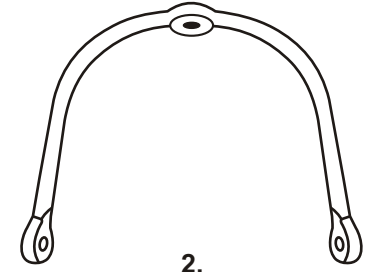

2. Aluminium handle upper hole is for make fix the hook holder.

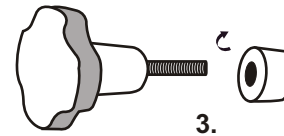

3. The aluminium flower gap will be get across from the aluminium handle side hole.

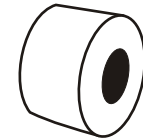

4. Aluminium round circle is for the support of aluminium flower grip. it will be place between handle & flower grip rode.

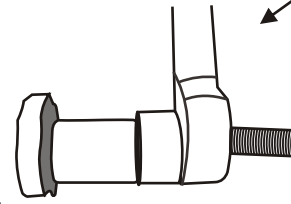

5. now the all 3 parts one together bined.

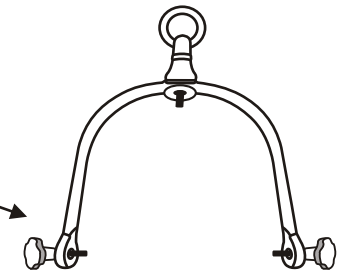

6. now the handle is with hook holder and flower grip.