

Please note the information contained in these instructions and save these manual

**TECHNICAL DATA:**

HOLDER OUTPUT:- MAX 60 W E27 220-240 V

**INSTRUCTIONS FOR USE:-**

- 1- THE Lamp is for ceiling purpose only.
- 2- The 3 core wire is used , highly protected and safe.
- 3- The connector with junction box is fixed in the ceiling cup for safety purpose.
- 4- The lamp is with chain and hook for hanging.
- 5- Complete fitting is as per CE European slandered.
- 6- The hanging chain is 1 mtr.
- 7- The lamp finish reflects the interior decoration colors.
- 8- The lamp is completely assembled, there is no need to change any fitting,
- 9- The product parts manual is inserted just for the acknowledgement.

**WARNING:-**

- 1- Do not put the lamps near the flammable or any explosive product.
- 2- Do not open under the pane by oneself.
- 3- Keep the product clean and clear for good lighting function.
- 4- If the item not works so smoothly please check the bulb holder inside the lamp shade or you can change the bulb only.
- 5- This lamp is only for indoor use.
- 6- The external flexible cable of the lamp can not be replaced, if the cable is damaged, the lamp wiring can be change by professional electrician only.
- 7- Keep away from the reach of children.
- 8- Please keep product untouched and unshakable, it should not be waving while hanging.

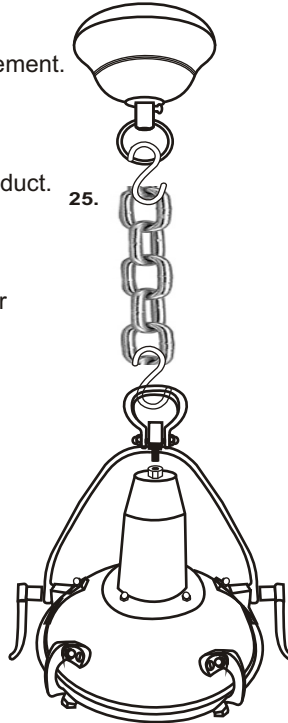
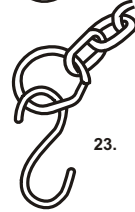







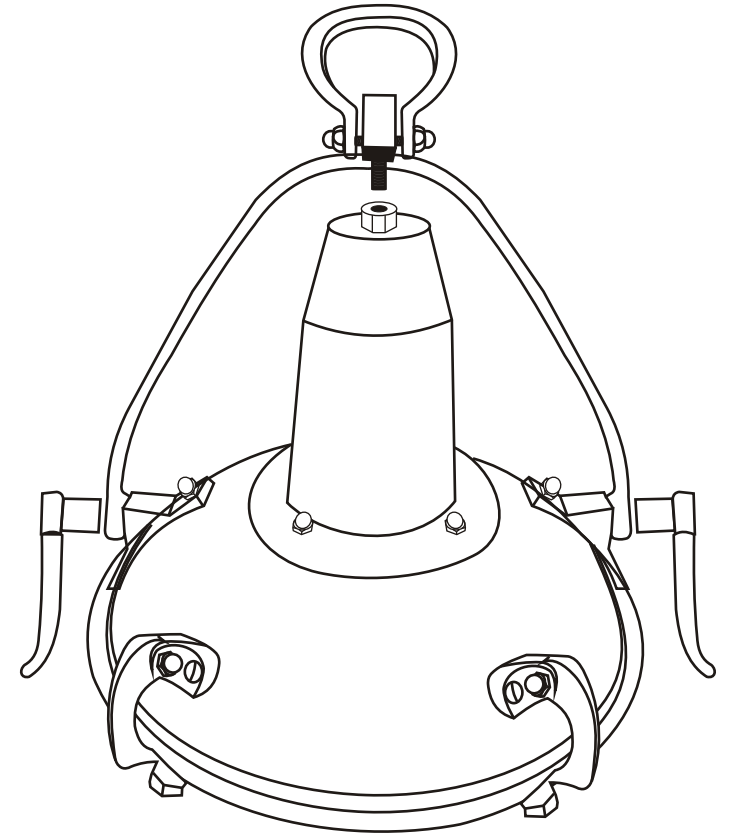







WWW.GAZQA.COM

ITEM # : 90219

DESC. : Raw HL II Nickel

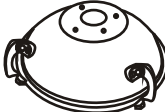

# THE MANUAL OF LAMP PARTS

1.  Hook Holder
2.  Nipple
3.  Studd
4.  Varshal
5.  Screw
6.  Aluminium Handle of Light
7.  Aluminium Arms
8.  Both side handle
9.  Inside Screw & Upper Screw
10.  Glass Ring
11.  Shade Below Ring
12.  Alum. Shade Cap
13.  Alum. Screw Grip
14.  Combine the shade Screw
15.  Screw Bold

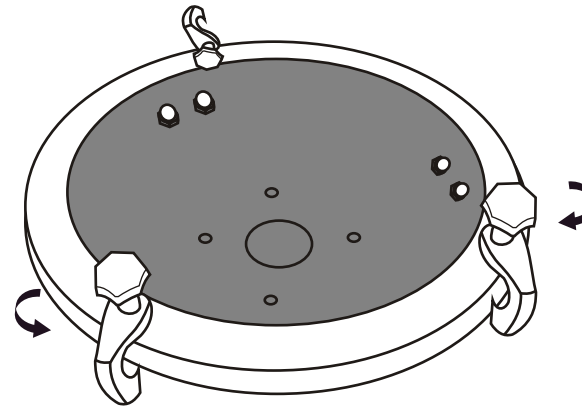

19.

Below view of shade with  
glass ring & fitting

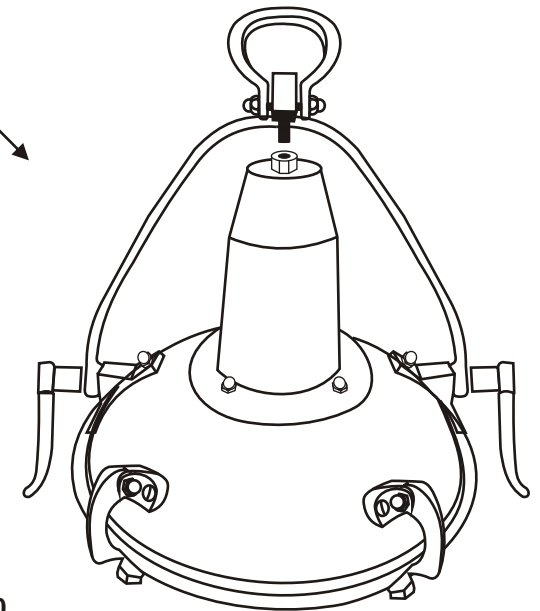
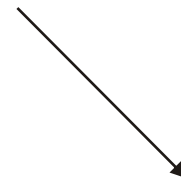

20.

Now the lamp is complete  
with pearls fitting.

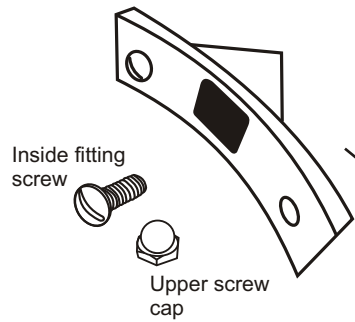

**6.**  
Aluminium handle 4 arms joining part. it will be on the both side of handle.

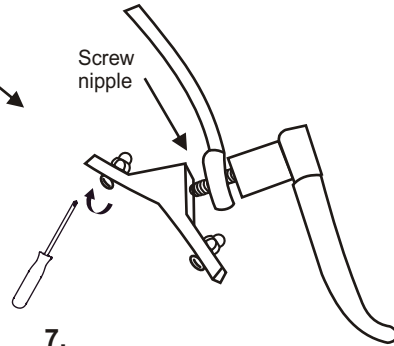

**7.**  
The aluminium arms will be with screw nipple, more which will be inserted across to the handle 4 will get insert into the arms joining part. the arms nipple will be fit in the joining part.

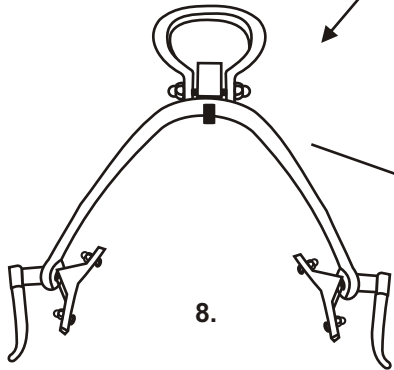

**8.**  
Now the handle is complete with hook holder & arms both side.

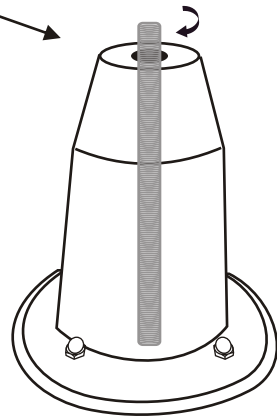

**9.**  
The one stud will be upper side of cap 4 one stud will be flighted from inside of the cap.

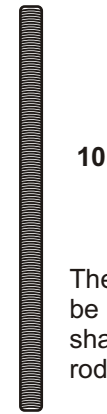

**10.**

The round nipple rod will be fit from the upper of shade cap with the use of rod stud & wash.

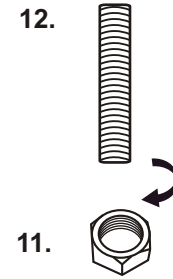

**12.**

**11.**

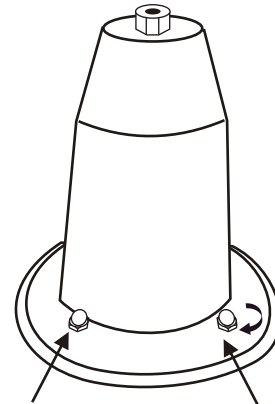

4 screw cap will be the to combine shade 4 cap.

**13.**

Now the shade cap is ready to be fill on the shade by the use of upper screw cap.

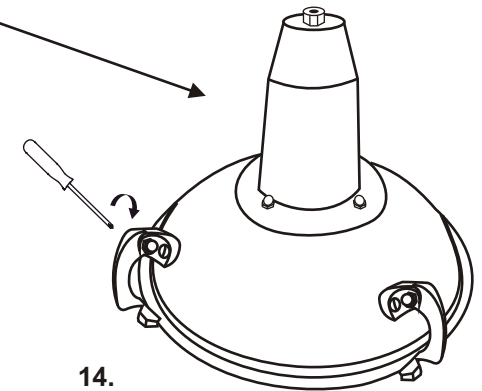

**14.**

Now the upper cap 4 shade is rew joint

# MANUAL WITH INSTALLATION DESCRIPTION OF LAMP PARTS

