

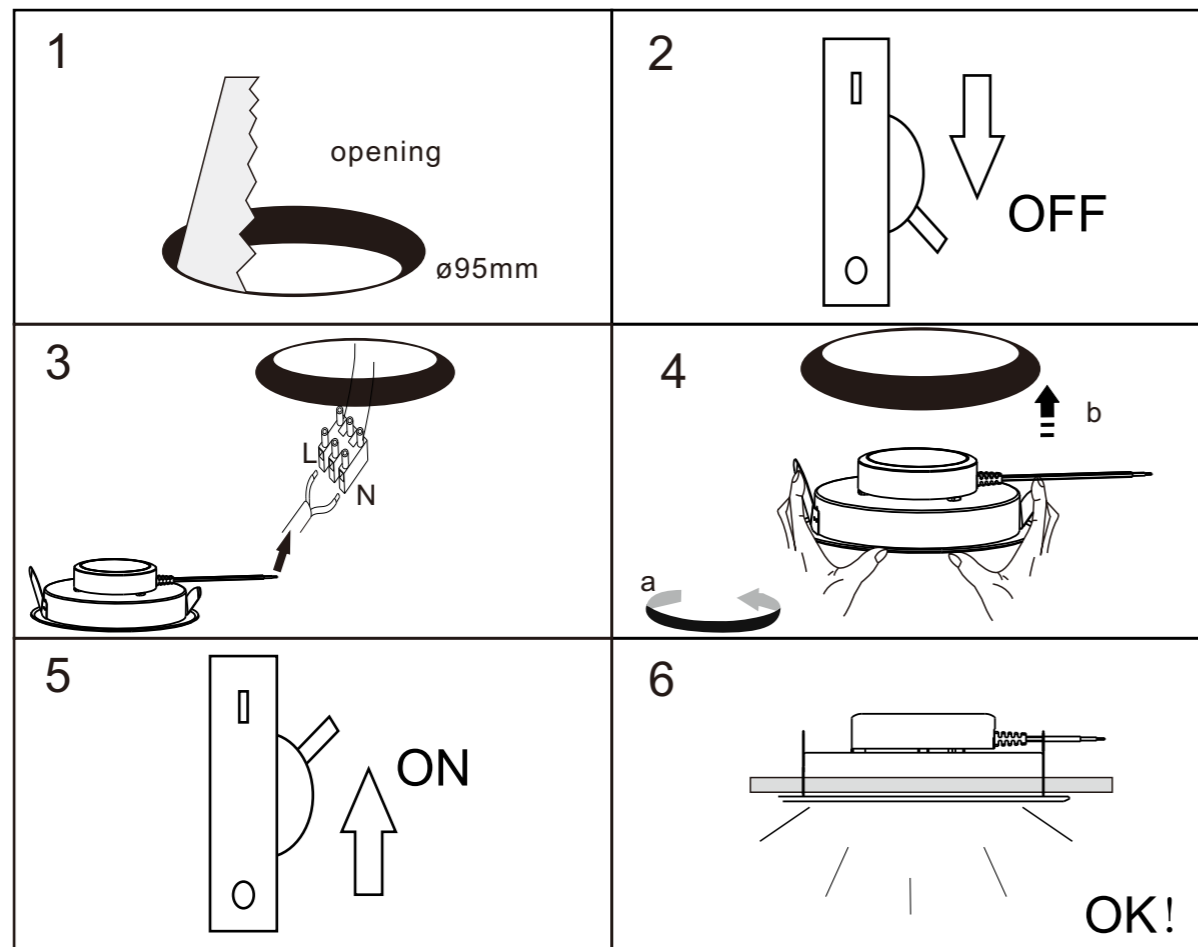

WWW.QAZQA.COM



IP44
QAZQA



WWW.QAZQA.COM

Radem DL 6W White 89987

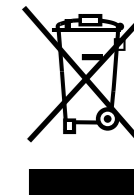

Instructions:

1. Input 220-240V, 50Hz, for rated wattages, please refer to the label on the product.
2. Do not replace the bulb or any other part when the lamp is switched on.
3. The lamp must be fitted with at least 0.8mm space between any objects.
4. If the plastic shield is damaged, please contact Lamp and Light.
5. Please do not install this lamp into a damaged or deformed ceiling.
6. Any LED modules are non-replaceable.
7. Under no circumstances, can the lamp be covered with heat insulation, gaskets or similar materials.
8. If the external cable of the lamp is damaged, it must be replaced by the manufacturer, or a qualified electrician to avoid any electrical hazards.
9. The lamp should only be used with its protective plastic shield in place.
10. The lamp is suitable for indoor use only.
11. To avoid a potential lamp/bulb failure, it is recommended that the lamp is switched off at least once a week.

This lamp is produced according to the strict regulations of the Safety Norm EN – 60 598

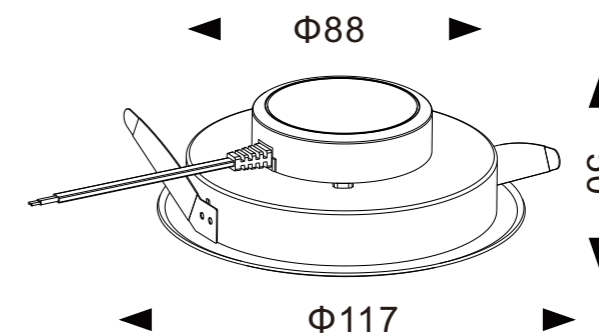

QAZQA