

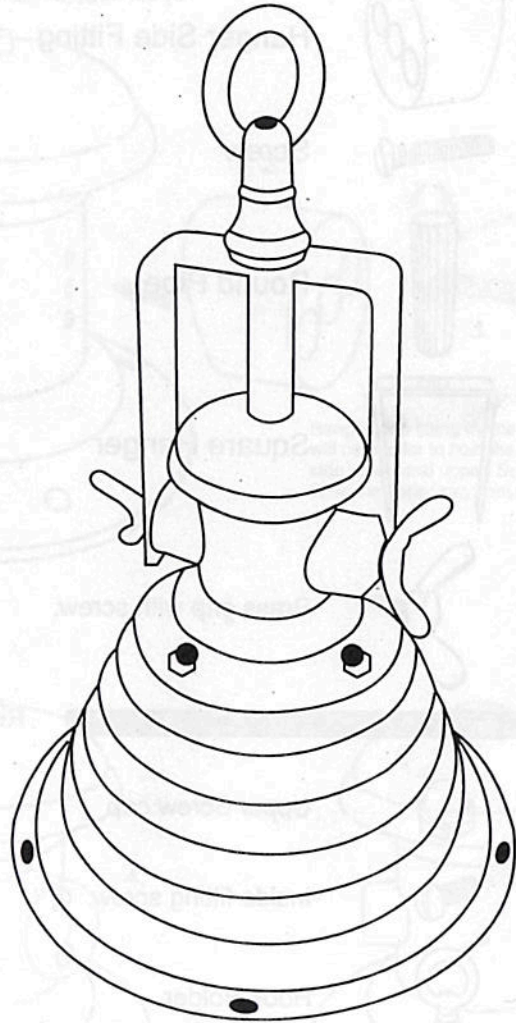

WWW.QAZQA.COM











ITEM # : 10655

DESC. : Knox HL S Chrome



QAZQA

THE MANUAL OF LAMP PARTS

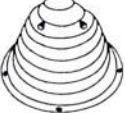
1.  Upper Cap
2.  Hanger Side Fitting
3.  Screw
4.  Round Pipe
5.  Square Hanger
6.  Brass grip with screw.
7.  Rod
8.  Upper Screw cap
9.  Inside fitting screw.
10.  Hook Holder
11.  Lamp Shade

MANUAL WITH INSTALLATION DESCRIPTION OF LAMP PARTS

Upper cap is used for the complete fitting of lamp and small holes will get different screw fittings.

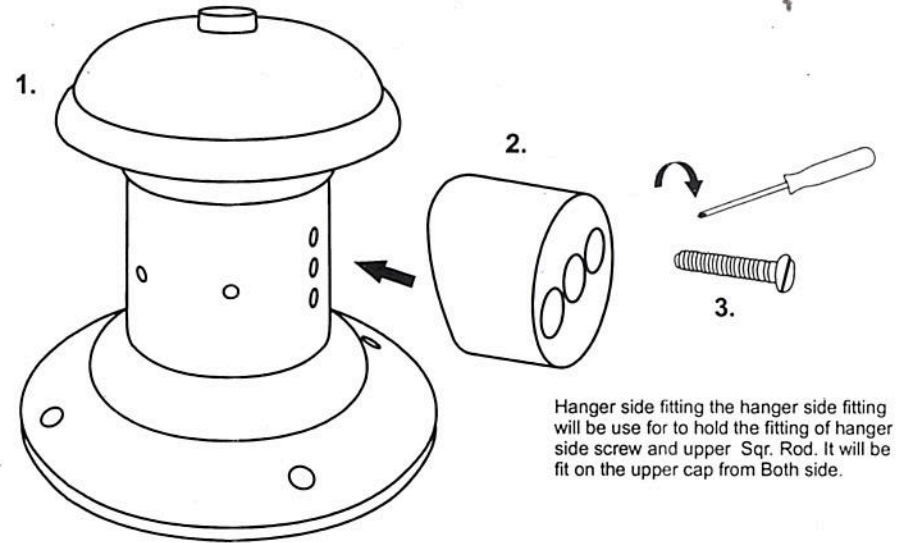

Hanger side fitting will use for to hold the fitting of hanger side screw and upper Sqr. Rod. It will be fit on the upper cap from Both side.

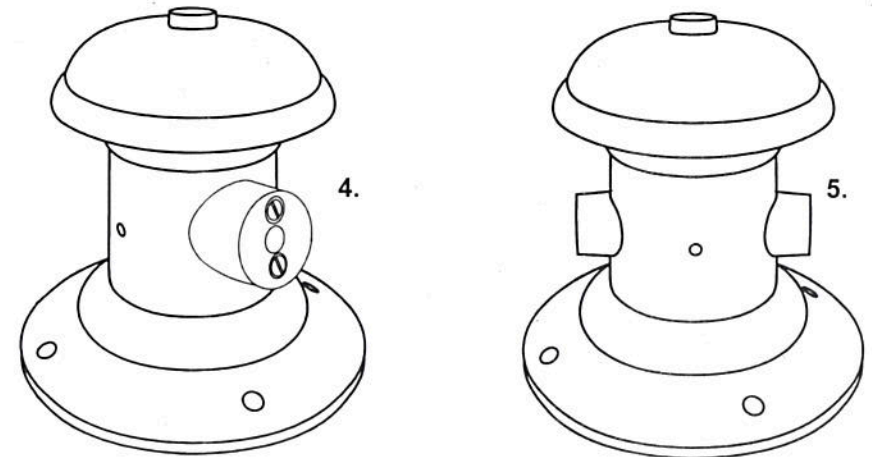



6.
Round Pipe will be fit under the Sqr. Rod hanger and on upper cup. It will be fix in the middle of upper cup hanger.

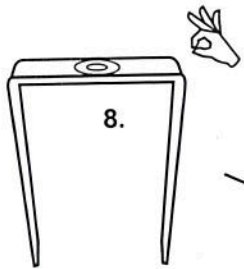
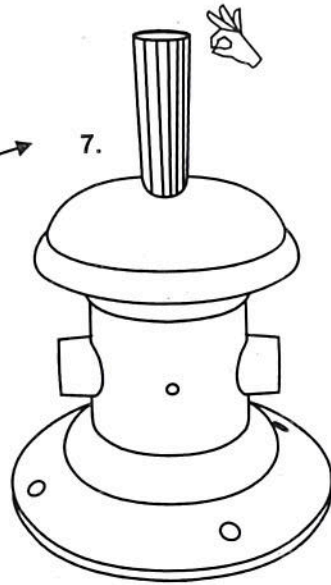

8.
Sqr. Rod hanger the Sqr. Rod hanger will be fix on the upper cap & will be fill from both side hanger fitting by brass grip with screw.

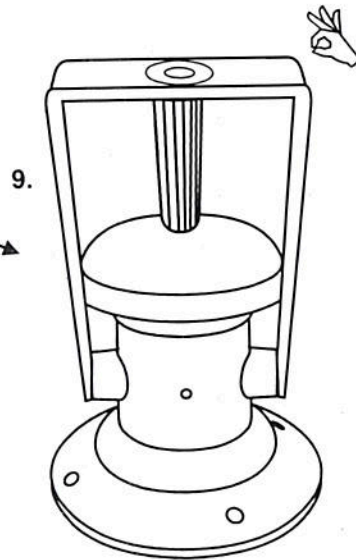

9.
Now the upper cup is fixed with sqr. rod gange and side fitting from both side

Brass grip with screw.

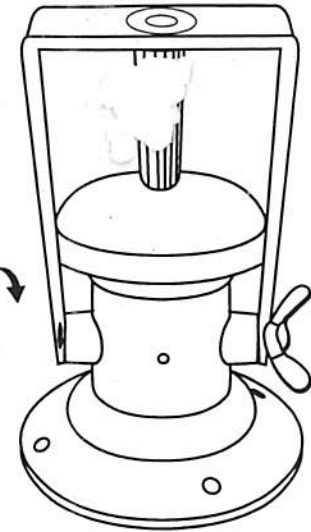

10.
Now the upper cup with complete outside fitting.

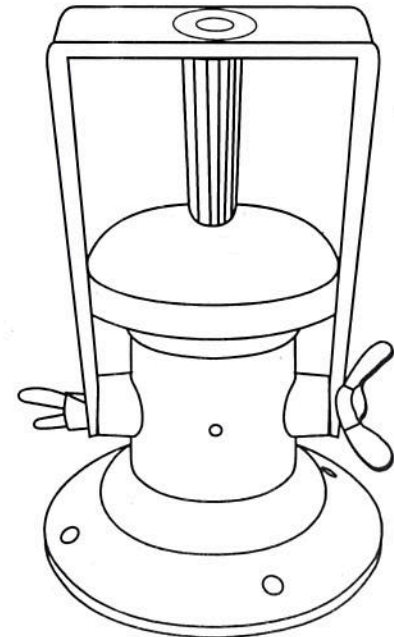

Round Nipple Rod

It will be use to attach upper cup fitting with the round lamp shade. It will be insert from inside of lamp shade.



13.

The Rod studd & Ring washer will be light on round nipple Rod and it will be inside of lamp shade.

Ring washer

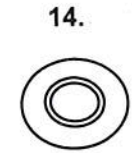

14.

Rod Studd



15.

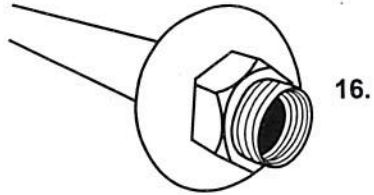

16.

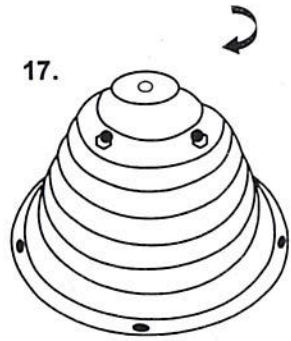

17.



Lamp shade

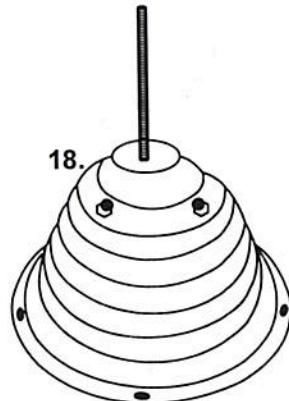

18.

Now the lamp shade is the round nipple Rod.

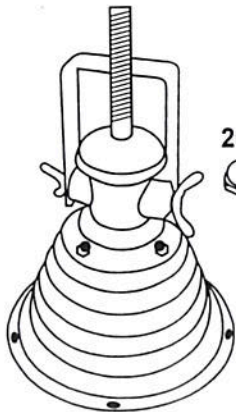

20.

Upper Screw cap



19.

Inside fitting screw.



The upper fitting cup will be place on the lamp shed with Round Nipple Rod. The round nipple Rod will be get across from inside of the upper cup.

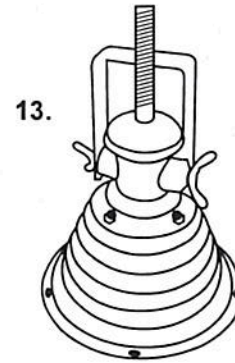

13.

Now the lamp shad is with upper cup fitting and inside round nipple Rod.

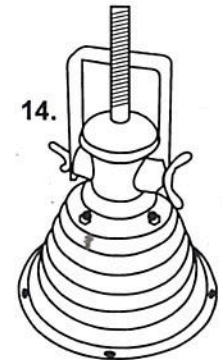

14.

This is the round nipple Rod which will come up of the Sqr. Rod hander & here we fix screw the aluminium inside casted hole Holder.

Hook holder aluminium casted.



15.

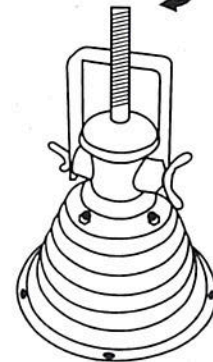

The hook holder will on tightly screw on the upper side of screw Rod hanger.

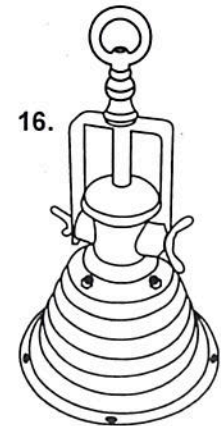

16.

Now The Lamp is Complete with Parts Fitting

Please note the information contained in these instructions and save these manual

TECHNICAL DATA:

HOLDER OUTPUT:- MAX 60 W E27 220-240 V

INSTRUCTIONS FOR USE:-

- 1- THE Lamp is for ceiling purpose only.
- 2- The 3 core wire is used , highly protected and safe.
- 3- The connector with junction box is fixed in the ceiling cup for safety purpose.
- 4- The lamp is with chain and hook for hanging.
- 5- Complete fitting is as per CE European slandered.
- 6- The hanging chain is 1 mtr.
- 7- The lamp finish reflects the interior decoration colors.
- 8- The lamp is completely assembled, there is no need to change any fitting,
- 9- The product parts manual is inserted just for the acknowledgement.

WARNING:-

- 1- Do not put the lamps near the flammable or any explosive product.
- 2- Do not open under the pane by oneself.
- 3- Keep the product clean and clear for good lighting function.
- 4- If the item not works so smoothly please check the bulb holder inside the lamp shade or you can change the bulb only.
- 5- This lamp is only for indoor use.
- 6- The external flexible cable of the lamp can not be replaced, if the cable is damaged, the lamp wiring can be change by professional electrician only.
- 7- Keep away from the reach of children.
- 8- Please keep product untouched and unshakable, it should not be waving while hanging.

