

ACCESSORIES / OPTIONS: **USE LAMP MAX. 40W****DICROIC FILTER 100**
201 38 11

WAARSCHUWING Lees de algemene gebruiksvoorwaarden : **DEEL B**
AVERTISSEMENT Lire attentivement les conditions générales d'utilisation : **PARTIE B**
WARNUNG Lesen Sie die allgemeinen Gebrauchsanweisungen : **TEIL B**
WARNING Read the general directions : **PART B**
AMMONIZIONE Leggere attentamente le condizioni generali di utilizzazione : **PARTE B**
EDVERTENCIA Leer atentamente las condiciones generales de uso : **PARTE B**



 Correcte verwijdering van dit product (Elektrische & elektronische afvalapparatuur)
 Comment éliminer ce produit (Déchets d'équipements électriques et électroniques)
 Korrekte Entsorgung dieses Produkts (Elektromüll)
 Correct disposal of this product (Waste electrical & electronic equipment)
 Eliminación correcta de este producto (Material eléctrico y electrónico de descarte)
 Corretto smaltimento del prodotto (Rifiuti elettrici ed elettronici)

 Goederen zijn dubbel geïsoleerd en mogen niet geaard worden
 Les produits ont une isolation double et ne peuvent pas être mis à la terre
 Güter sind doppelt isoliert und müssen nicht geerdet werden
 Goods have double insulation and must not be grounded
 Los productos tienen un aislamiento doble y no se pueden conectar a tierra
 I prodotti possiedono un doppio isolamento e non devono essere collegati a terra

 Verlichtingstoestellen die geschikt zijn voor rechtstreekse montage op ontvlambare oppervlakken
 Luminaires appropriés à un montage direct sur des surfaces inflammables
 Für direkte Montage auf entflammbaren Flächen geeignete Lampen
 Luminaires suitable for direct mounting on flammable surfaces
 Luminarias aptas para montaje directo sobre superficies inflamables
 Apparecchi di illuminazione adatti a essere montati direttamente su superfici infiammabili

 Minimum afstand van de verlichte voorwerpen (meter)
 Distance minimale par rapport aux objets éclairés (mètres)
 Mindestabstand von beleuchteten Gegenständen (Meter)
 Minimum distance from lighted objects (metres)
 Distancia mínima de los objetos iluminados (metros)
 Distanza min. dagli oggetti illuminati (metri)

850°C Gloetest
 Fil incandescent
 Glowtest
 Glühtest
 Ensayo de recocido
 Filo incandescente

 Installeer het armatuur enkel in ruimten waar direct contact met water onmogelijk is.
 Cet équipement doit être installé dans des pièces hors de toute projection d'eau.
 Diese Leuchte darf nur in Räumen verwendet werden, in denen ein direkter Kontakt mit Wasser nicht möglich ist.
 This fitting should only be installed in rooms where direct contact with water is impossible.
 Este aparato solamente puede ser instalado en habitaciones donde el contacto directo con el agua sea imposible.
 Questo apparecchio di illuminazione deve essere installato solamente in locali in cui il contatto con l'acqua è impossibile.

 Bevestiging wand opbouw
 Montage mur appliqué
 Montage wand aufgebaut
 Fixation wall surface mounted
 Montaje pared montado al superficie
 Montaggio parete montato a superficie

 Opgepast warm oppervlak - niet aanraken - buiten bereik installeren
 Attention surface de contact chaude - ne pas toucher - installer hors d'atteinte
 Achtung heiße Oberfläche - Nicht Berühren - Nur unerreichbar installieren
 Caution hot surface - do not touch - install out of reach
 Precaución alta temperatura de la superficie - no tocar - instalar fuera de alcance
 Attenzione superficie calda - non toccare - installare in luogo non accessibile

02 HOLE PATTERN

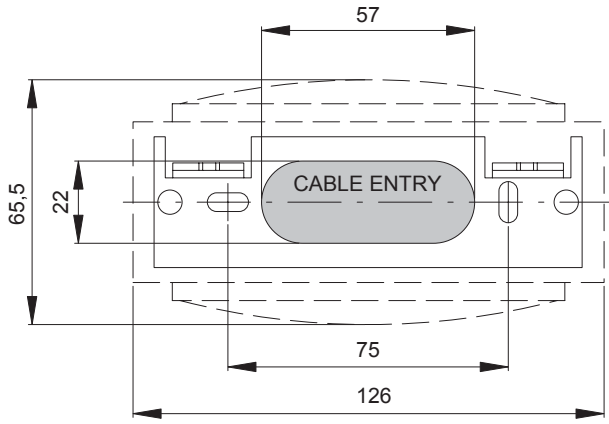

05 CABLE PROTECTION IN THE WALL

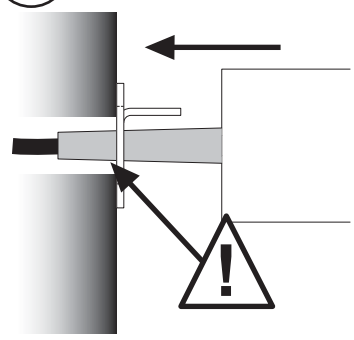

01. OPEN THE DEVICE
02. MAKE HOLE PATTERN
03. FASTEN THE BRACKET TO THE WALL
04. MAKE ELECTRIC CONNECTION
05. SLIDE THE DEVICE TO THE WALL
06. FASTEN THE SCREWS (2x)
07. (RE)PLACE LAMP
- 07b. PLACE FILTER (OPTION)
08. FASTEN THE COVER
09. SWITCH ON



03

