

INSTRUCTION MANUAL

NOTICE:

Read carefully before installation and well keep this manual in safe place.

Replace any cracked protective shields. It must be installed and assembled by a qualified electrician.

PARAMETER:

MODEL NO.:	44945	44946, 70087	45837, 45838, 45840, 45841
RATED VOLTAGE:	AC 220-240V, 50Hz	AC 220-240V, 50Hz	AC 220-240V, 50Hz
RATED WATTAGE	Max. 60W	Max. 60W	Max. 100W
SAFEGUARD GRADE	Class I	Class I	Class I
PROTECTION DEGREE	IP44	IP23	IP44
LAMPHOLDER	E27	E27	E27

INSTALLATION ILLUSTRATION:

Before attempting to install units, ensure power is off and pay attention to all following steps below:

A. INSTALLATION OF WALL LAMP: 44945, 44946, 70087, 45840 , 45841 (fig.1)

1. First install plastic expansion piece into the wall.
2. Then insert two fixed screws into plastic plate.
3. Feed wire from the wall to the protective sleeve. Fix the plastic plate onto the plastic expansion piece with self-tapping screws.
4. Connect the supply leads to the wire of lamp with terminal brown(L) to brown, blue(N) to blue, and greenish-yellow ⊕ to greenish-yellow.
5. Insert the terminal into plastic plate.
6. Mount & tighten the lamp with fixed screws and domed nuts.
7. Open upper lamp cover, screw a new bulb into lampholder, and close the upper cover, the bulb must not exceed wattage specified on the fixture label.

B. INSTALLATION OF POLE LAMP: 45838 (fig.2)

1. Fix the pipe for installation on the plane of the installing lamp.
2. Connect the supply leads to the wire of lamp with terminal brown(L) to brown, blue(N) to blue, and greenish-yellow ⊕ to greenish-yellow.
3. Secure the lamp onto the pillar with the fixed screws.
4. Open the upper cover, twist a new bulb into lampholder, the bulb must not exceed wattage specified on the fixture label.
5. Close the cover.

C. INSTALLATION OF STANDING LAMP: 45837 (fig.3)

1. First install the plastic expansion piece on the surface of the installing lamp.
2. Connect the supply leads to the wire of lamp with terminal brown(L) to brown, blue(N) to blue, and greenish-yellow ⊕ to greenish-yellow.
3. Secure the lamp onto the pillar with the fixed screws.
4. Open the upper cover, twist a new bulb into lampholder, and close the upper cover, the bulb must not exceed wattage specified on the fixture label.

QAZQA



SAFETY DIRECTIONS:

1. Before starting the installation, the power must be disconnected.
2. After turning on the switch, temperature of bulb rises gradually, when bulb lights or not completely cooled, do not touch bulb with bare hand.
3. If you should change bulb, switch off the power first, then change the bulb after the bulb has been cooled enough(for details see the specified of changing bulb).
4. The bulb must not exceed the specified wattage.
5. When the lamp cover is broken, it must be changed as soon as possible. Never use the bulb without lamp cover.
6. Don't look at the lighting directly.
7. Be sure to connect ground lead.
8. Must use the H05RN-F 3G1mm² wire.
9. Must use the double-pole-off switch.

INSTRUCTION OF BULB REPLACEMENT:

1. Turn off the power.
2. Open the upper cover of the lamp.
3. Don't touch bulb with bare hand.
4. After the bulb has cooled ,twist out the bulb slightly.
5. When installing new bulb, twist bulb into socket carefully.
6. Before turning on the power, the upper lamp cover must be correctly assembled.

Fig.1

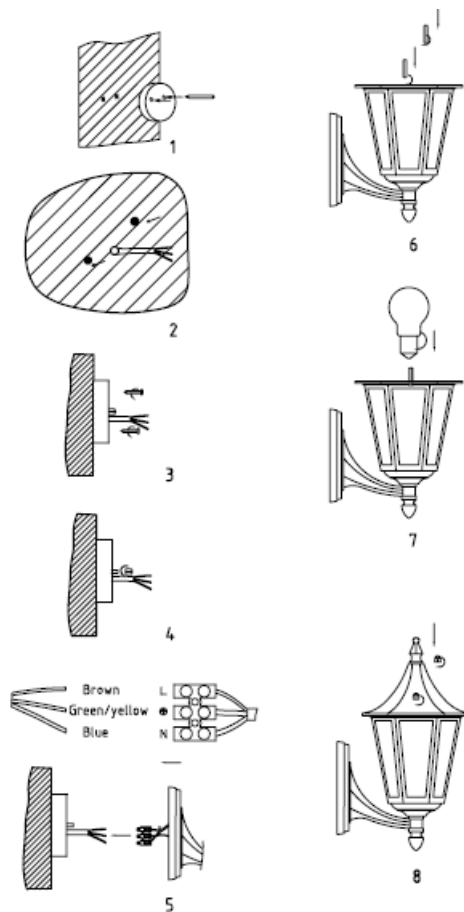



WWW.QAZQA.COM

Fig.2

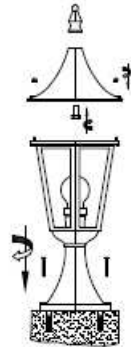
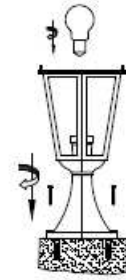
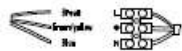
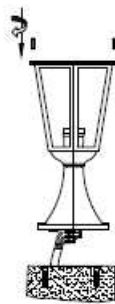
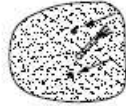
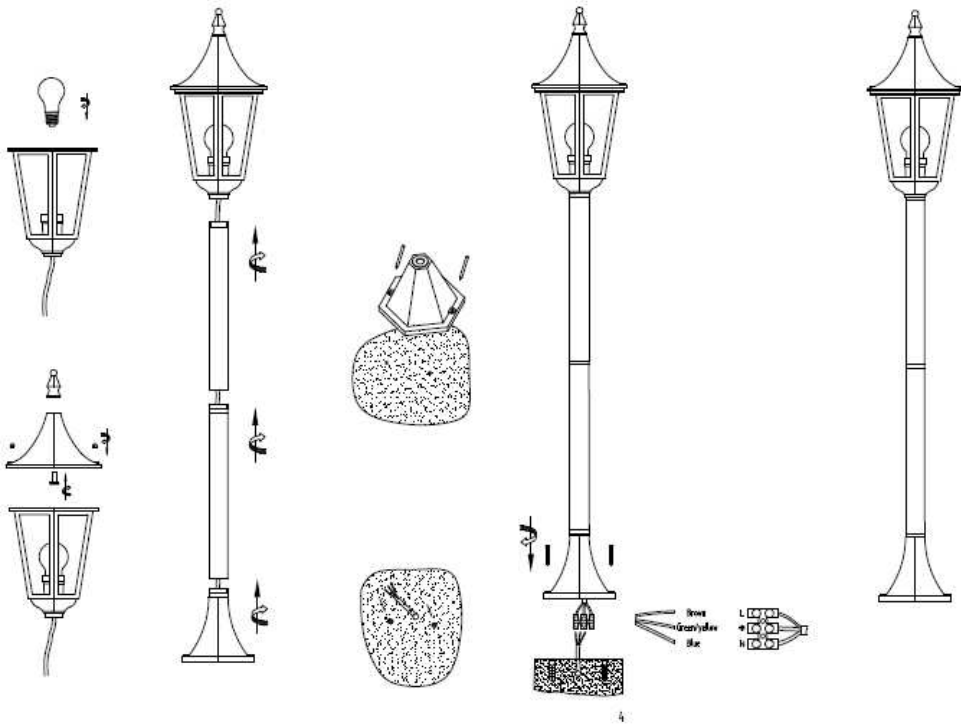

Fig.3

QAZQA