

A

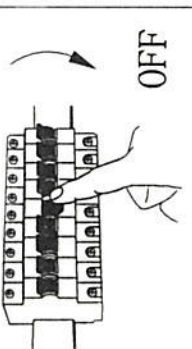

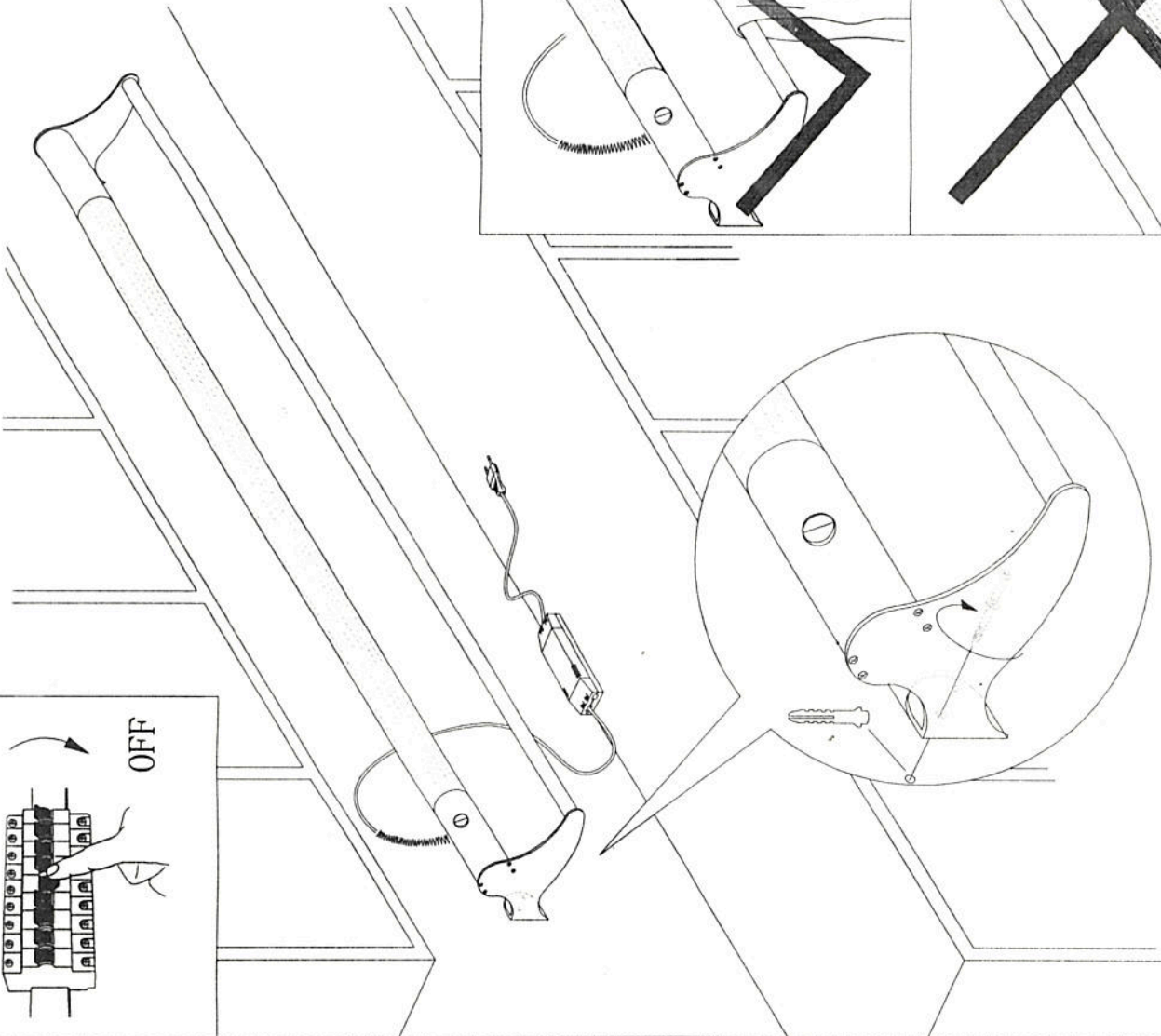

B

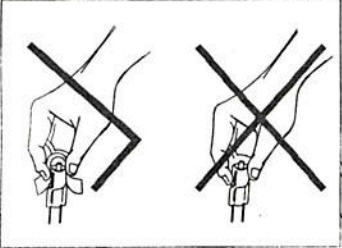
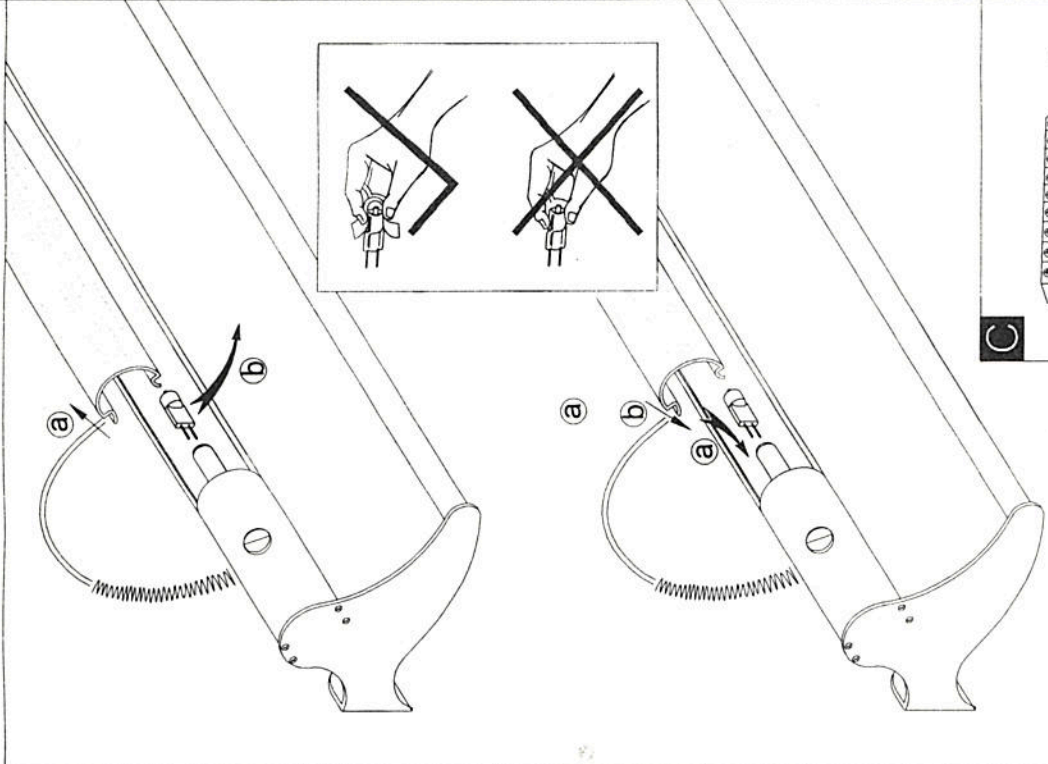
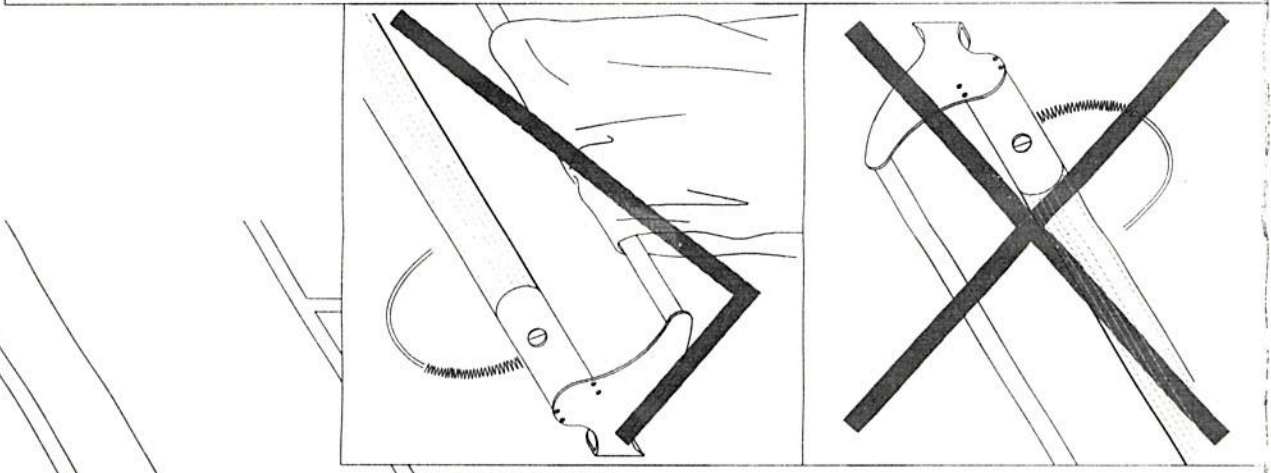
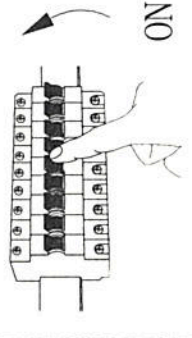

C

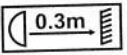
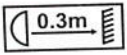
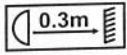
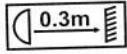
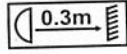
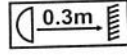
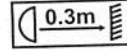
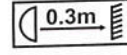
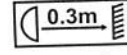
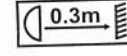
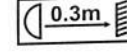
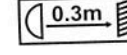
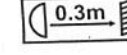
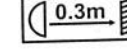
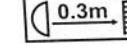
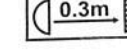
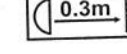
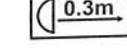
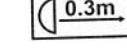
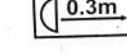
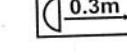
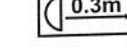
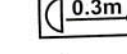
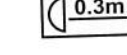
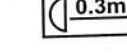

D		Der Abstand zwischen Leuchtmittel und angestrahlter Fläche muß mindestens 0.3 m betragen.
GB		The distance between halogen - bulb and any surface area must be a minimum of 0.3 m.
F		La distance minimale entre l'ampoule et la surface éclairée doit être de 0.3 m.
I		La distanza minima tra la lampadina e la superficie da illuminare deve essere di 0.3 m.
E		La distancia minimal entre la bombilla y la superficie iluminada ha de ser por lo menos 0.3 m.
CZ		Vzdálenost mezi světelným zdrojem a osvětlenou plochou musí být minimálně 0.3 m.
NL		De afstand tussen de spot en het belichte punt moet minstens 0.3 m zijn.
RO		Distanta minima între becul de halogen și suprafața luminată trebuie să fie cel puțin de 0.3 m.
H		A távolságnak az izzó és a megvilágított felület között minimum 0.3 M - nek kell lennie.
DK		Afstanden mellem lyskilden og den belyste flade skal være mindst 0.3 m.
N		AVSTANDEN MELLOM HALOGEN LYSKILDEN OG BELYST OBJEKT MÅ VÆRE PÅ MINIMUM 0.3 M.
S		Avståndet mellan ljuskällan och belyst yta skall vara minst 0.3 m.
RUS		Минимальное расстояние между лампочкой и освещенной поверхностью должно составлять 0,3 м.
GR		Η απόσταση μεταξύ της λάμπας αλογόνου και οποιασδήποτε άλλης επιφάνειας πρέπει να είναι λιγότερο από 0,3 μ.
TR		Ampul'le ışığın değıdiği yerle arası en az 0,3 m olmalı
FIN		Halogeneeni lampun minimietäisyys valaistavasta tai muusta pinnasta on 0,3m
P		A DISTÂNCIA ENTRE A LAMPADA E A SUPERFICIE ILLUMINADA TEM QUE SER NO MINIMO DE 0,3M
HR		RAZMAK IZMEĐU ŽARULJE I ČVRSTE POVRŠINE MORA BITI MINIMALNO 0,3M
SLO		Razdalja med žarnico in osvetljeno površino ne sme biti manjša od 0,3 m.
PL		ODLEGŁOŚĆ MIĘDZY ŻARÓWKĄ HALOGENOWĄ, A OŚWIETLANĄ POWIERZCHNIĄ MUSI WYNOŚIĆ MINIMUM 0,3M.
SCG		Razmak između halogene sijalice i drugih površina mora biti minimum 0.3 m.
SK		Vzdialenosť medzi svetelným zdrojom a ožarovanou plochou musí byť minimálne 0,3 m.
BG		Минимално отстояние от осветяваната повърхност 0.3 м.
LV		Minimālajam attālumam starp spuldzi un apgaismoto virsmu jābūt 0.3m.
LT		Tarp halogeninės lemputės ir bet kurio paviršiaus turi būti mažiausiai 0.3 m atstumas.
EST		Vahemaa halogeenlambi ja valgustatava pinna vahel peab olema vähemalt 0.3m.
CHN		光源到被照物体的距离不小于0.3米。

