



WWW.QAZQA.COM

ATTENTION: FOR THIS OPERATION YOU HAVE TO CUT OFF THE POWER

Class II lamp

MAXIMUM

220~230V 50Hz PAR16 MAX 50W/GU10

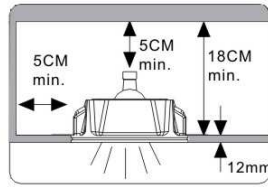

46214

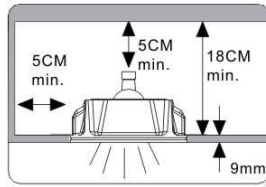
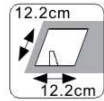

46215

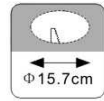

1

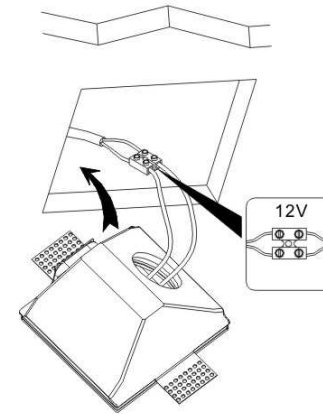

2

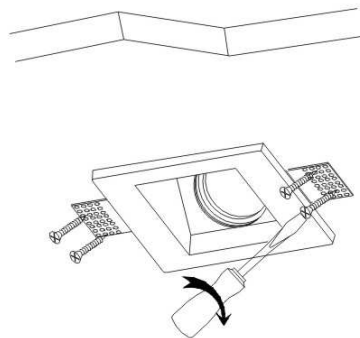

3

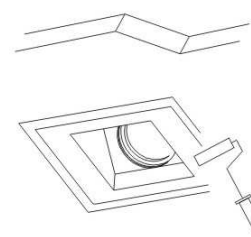
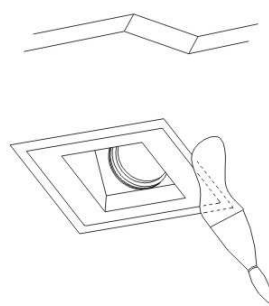

4

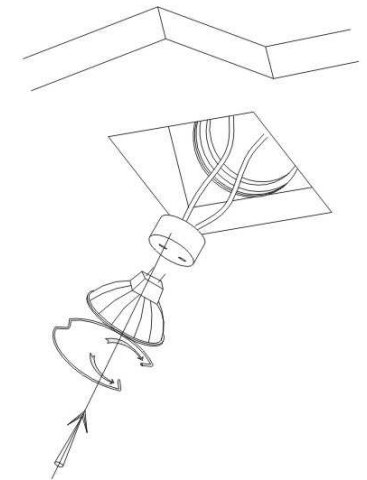

QAZQA