

# INSTRUCTION



WWW.QAZQA.COM

Length between the suspension cups

Watt	21W	28W	35W
L (mm)	849	1149	1449

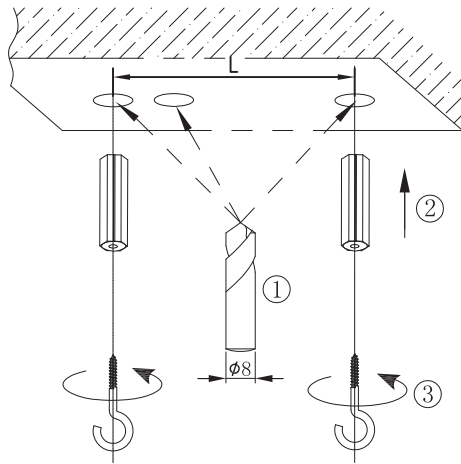

①

Attention:  
The fixture should be assembled and installed by professionals!

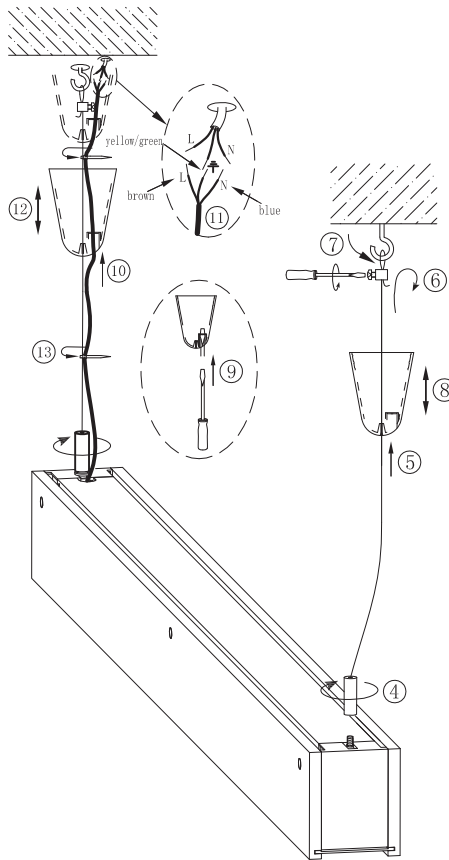

③

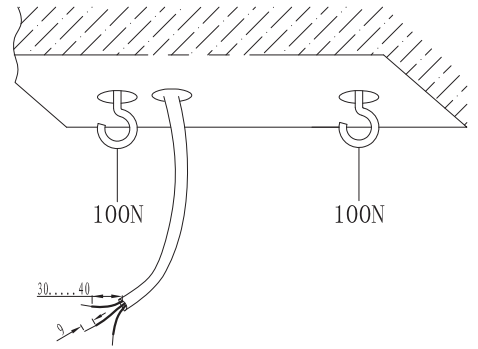

②

The steps to replace the fluorescent tube:

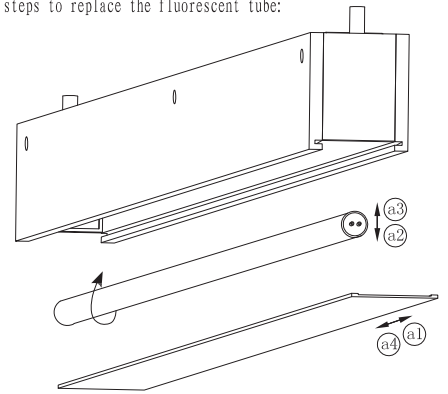

④

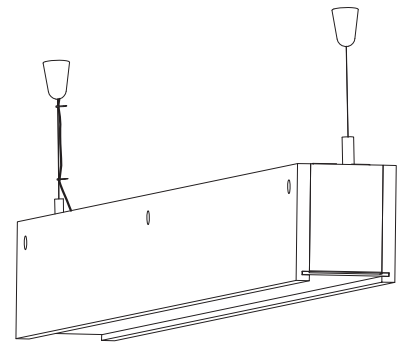

⑤

Length for the housing

Watt	21W	28W	35W
L (mm)	880	1180	1480

