

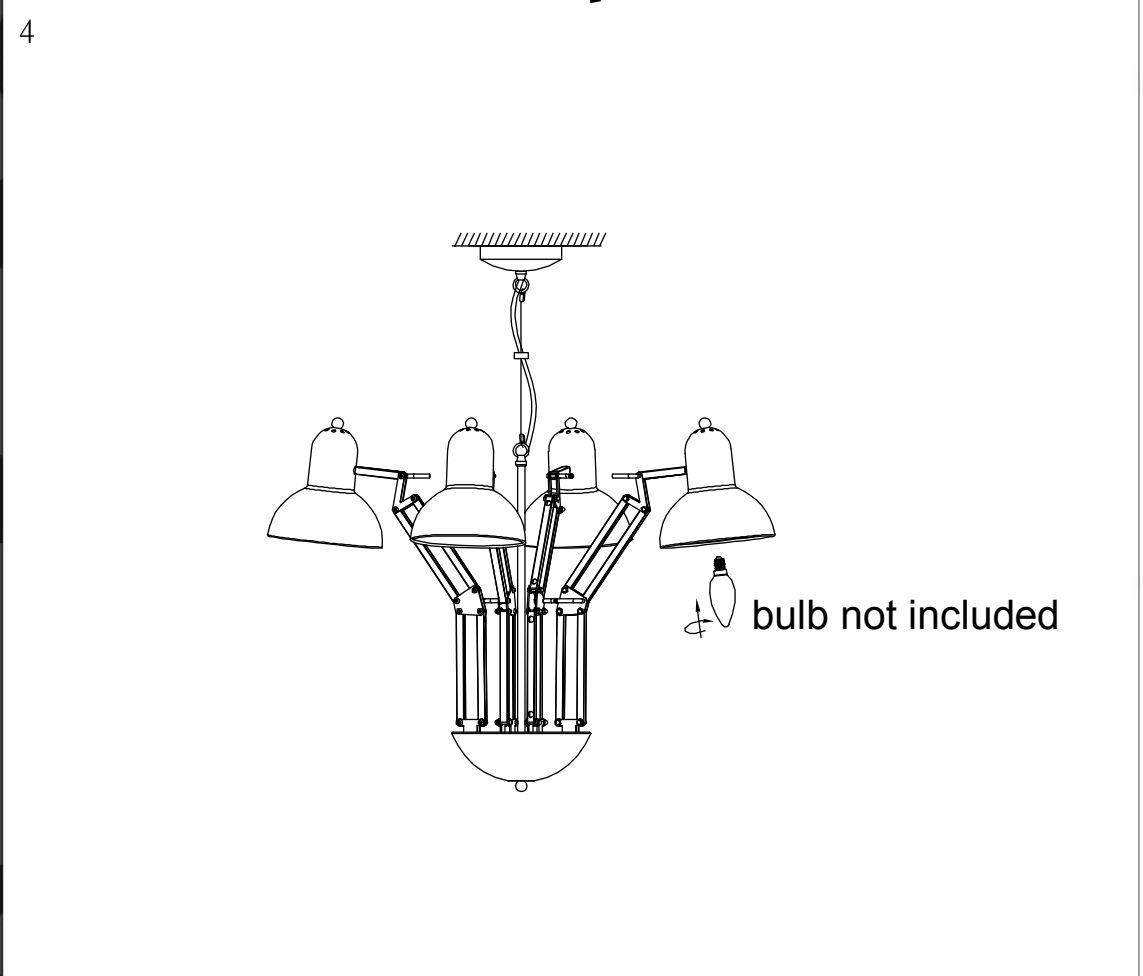

WWW.QAZQA.COM

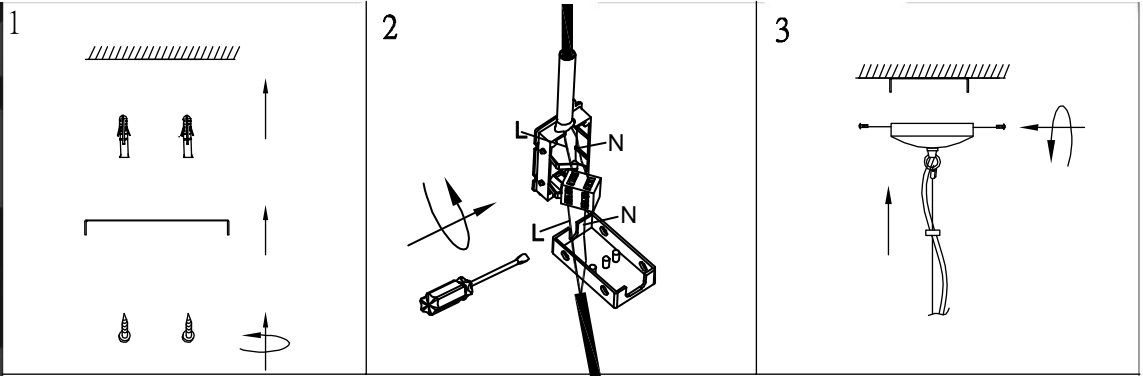

45765

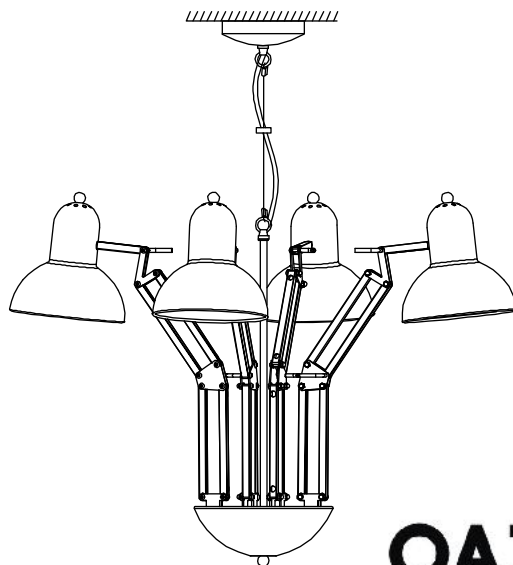

**QAZQA**