

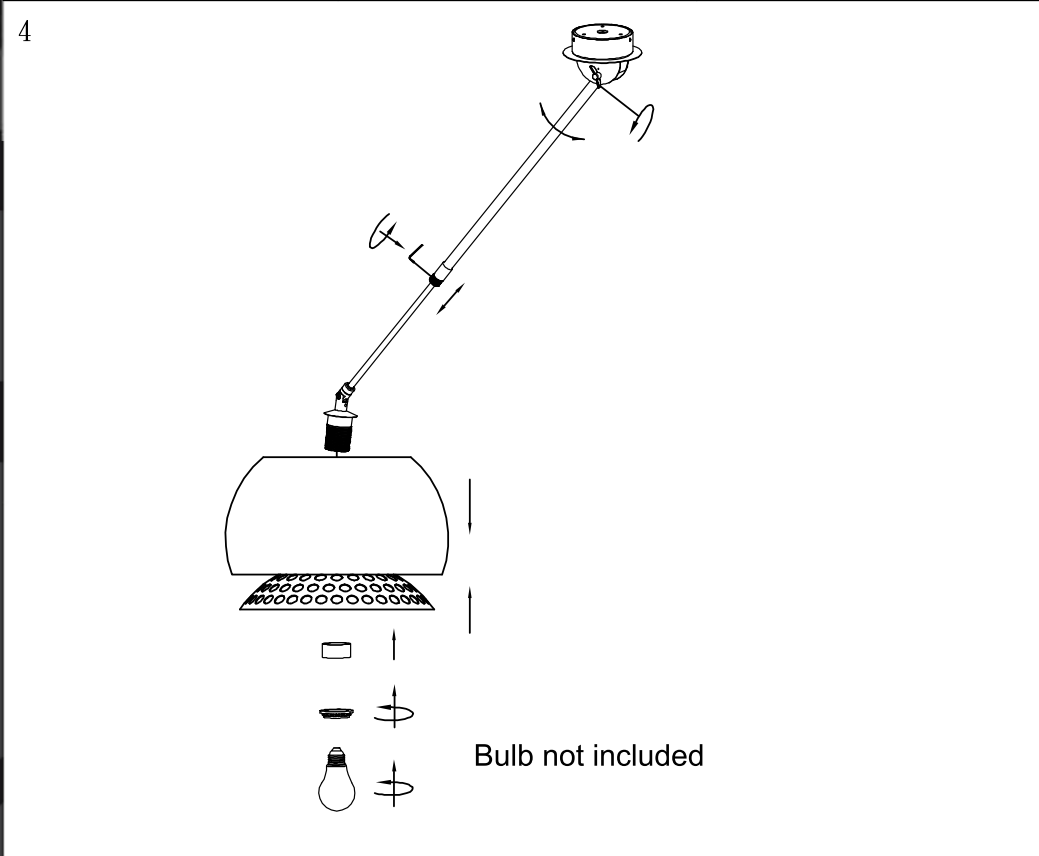

WWW.QAZQA.COM

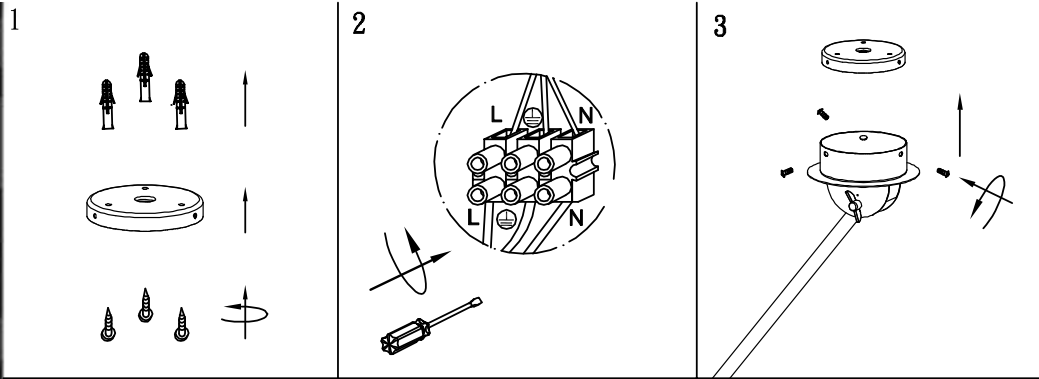

45443

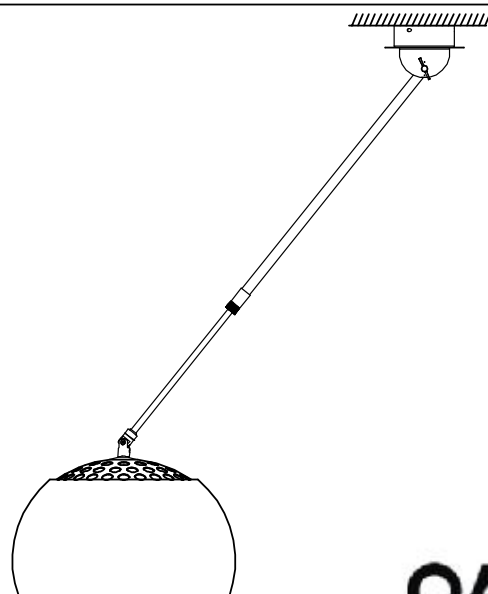

**QAZQA**