

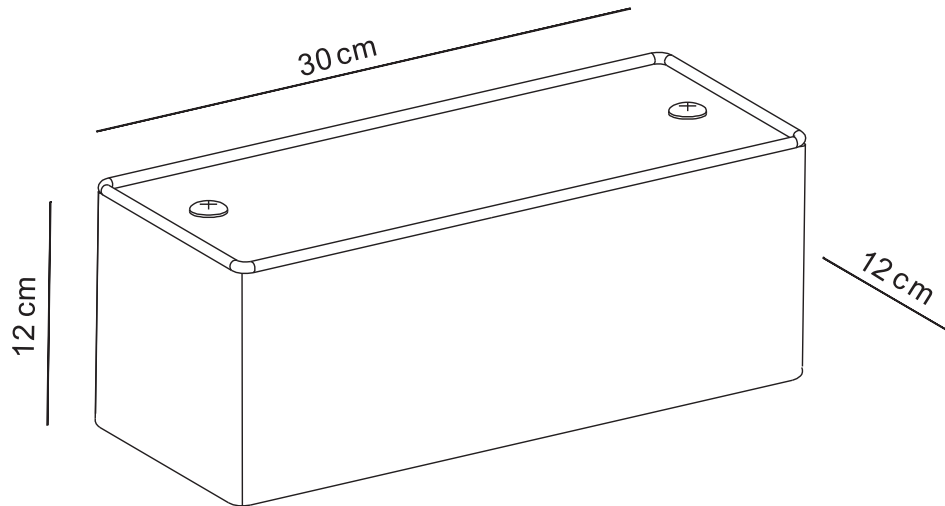

WWW.QAZQA.COM

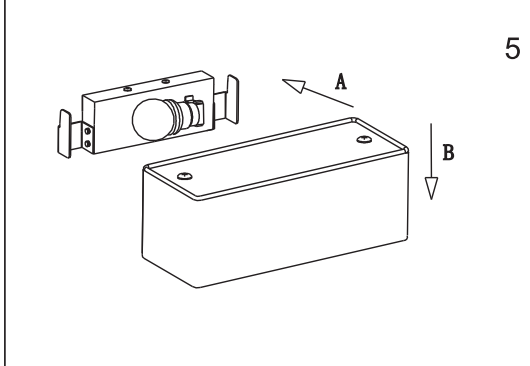
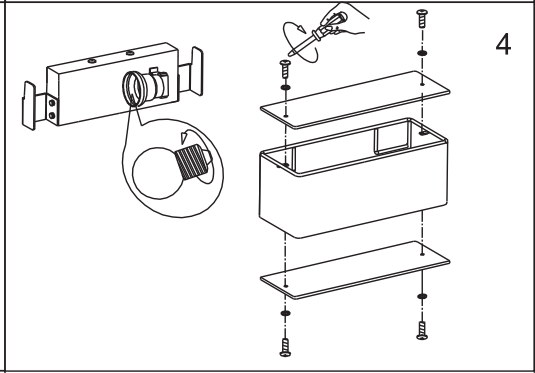
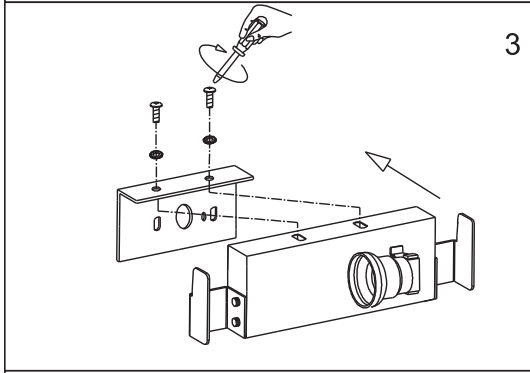
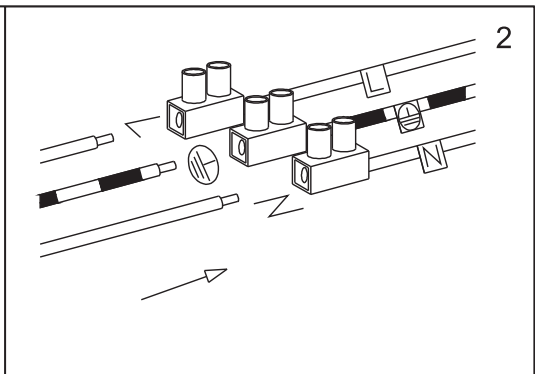
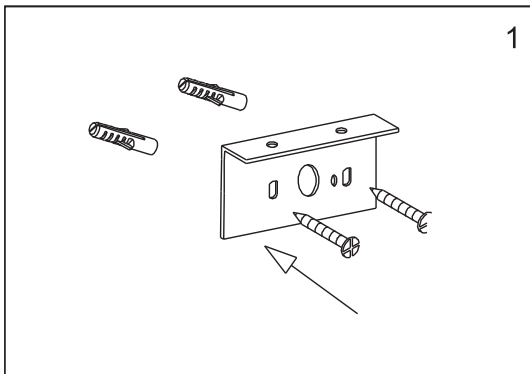

**QAZQA**  
45306