

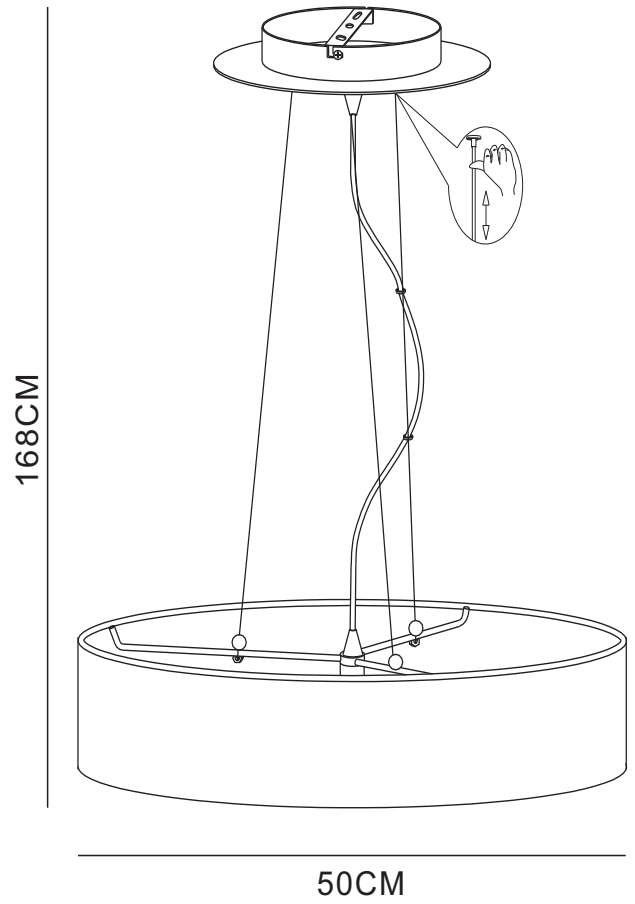

WWW.QAZQA.COM

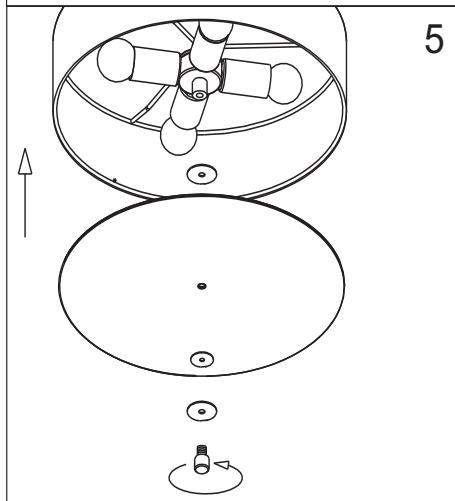
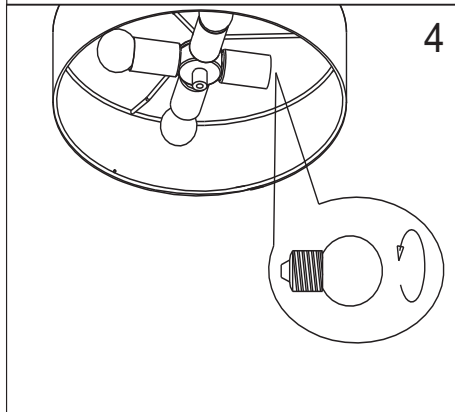
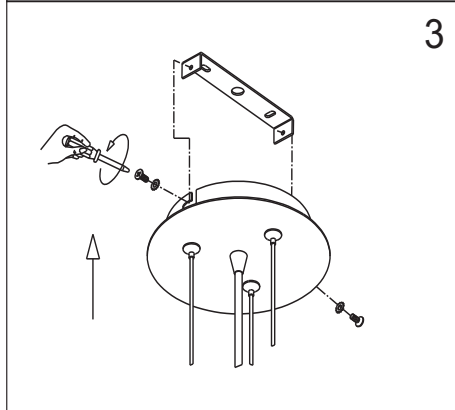
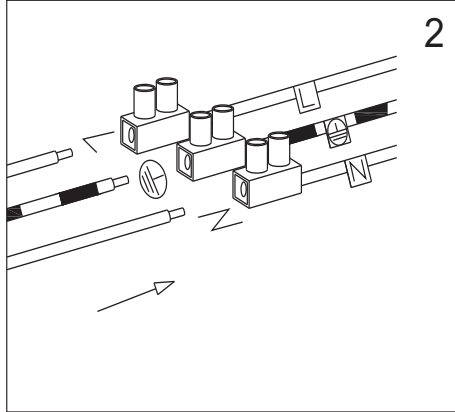
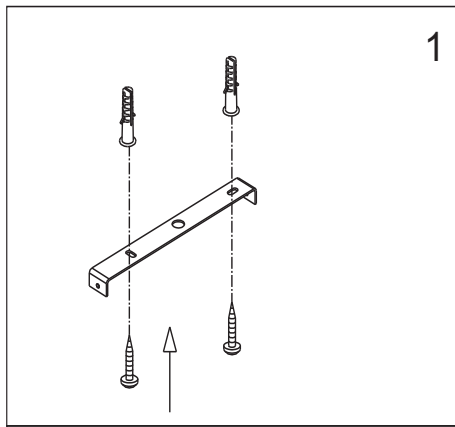

**QAZQA**

45272