

Paul Neuhaus

Paul Neuhaus GmbH
Olakenweg 36 · D-59457 Werl

+49(0)2922 9721 0
+49(0)2922 9721 9120
info@neuhaus-group.de

<https://scm.paul-neuhaus.de/public/conformity/>



D | Montageanleitung • GB | Fitting instruction

- DE** Dieses Produkt enthält eine Lichtquelle der Energieeffizienzklasse <E>.
- GB** This product contains a light source of energy efficiency class <E>.
- FR** Ce produit comprend une source de lumière de classe d'efficience énergétique <E>.
- BG** Продуктът съдържа източник на светлина с клас на енергийна ефективност <E>.
- CZ** Tento výrobek obsahuje světelný zdroj třídy energetické účinnosti <E>.
- DK** Dette produkt indeholder en lyskilde af energieeffektklasse <E>.
- EL** Αυτό το προϊόν περιέχει πηγή φωτός της τάξης ενεργειακής απόδοσης <E>.
- ES** Este producto contiene una fuente de luz de la clase de eficiencia energética <E>.
- ET** See toode sisaldab valgusallikat energiatõhusklassiga <E>.
- FI** Tämä tuote sisältää energiatehokkuusluokan <E> valonlähteen.
- HR** Ovaj proizvod sadrži izvor svjetlosti energetskeg razreda <E>.
- HU** Ez a termék <E> energiahatékonysági osztályba tartozó fényforrást tartalmaz.
- IT** Questo prodotto contiene una sorgente luminosa della classe di efficienza energetica <E>.
- LT** Šis produktas yra su šviesos šaltiniu, kurio energinio efektyvumo klasė yra <E>.
- LV** Šis izstrādājums satur gaismas avotu, kas atbilst energoefektivitātes klasei <E>.
- NL** Dit product bevat een lichtbron van energie-efficiëntieklasse <E>.
- NO** Dette produktet inneholder en lyskilde i energieffektivitetsklasse <E>.
- PL** Produkt ten zawiera źródło światła o klasie efektywności energetycznej <E>.
- PT** Este produto contém uma fonte de luz da classe de eficiência energética <E>.
- RO** Acest produs conține o sursă de lumină din clasa de eficiență energetică <E>.
- RU** Данное изделие содержит источник света класса энергоэффективности <E>.
- SK** Tento výrobok obsahuje zdroj svetla triedy energetickej efektivity <E>.
- SL** Ta izdelek vsebuje svetlobni vir razreda energijske učinkovitosti <E>.
- SR** Ovaj proizvod sadrži izvor svetlosti energetske klase <E>.
- SV** Denna produkt innehåller en ljuskälla i energieffektivitetsklass <E>.
- TR** Bu ürün, enerji verimliliği sınıfına sahip bir ışık kaynağı içerir <E>.

837451

230V/50Hz~
1x LED-Board 33,3V DC / 35W
nicht wechselbar / not changeable

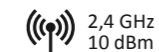

2,4 GHz
10 dBm

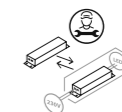

	35 W
	5.100 lm
	40 W
	2.800 lm
	LED-Board
t	25.000 h
Tk	2.700-5000 K
	15.000 x
	< 0,5 s

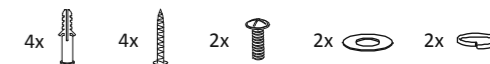
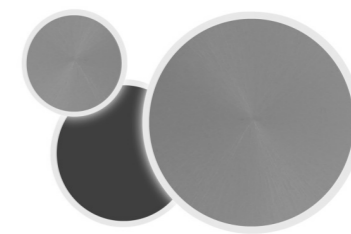

AAA, 1,5V



Inkl. IR-Fernbedienung
Incl. IR remote control



1 | Montage / fitting

als Deckenleuchte
as ceiling light

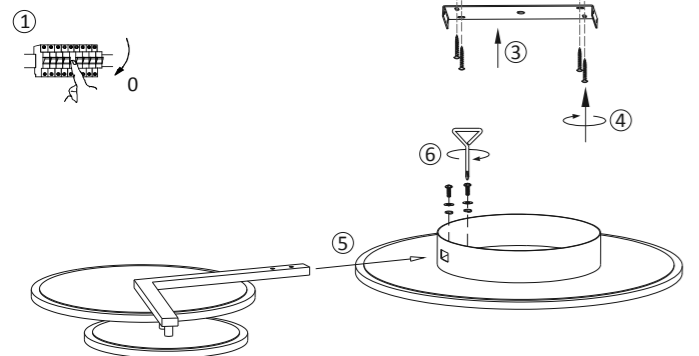

2 | Elektrischer Anschluss/ electrical connection

230Volt/50Hz-Anschluss
230 voltage/50 Hz connection

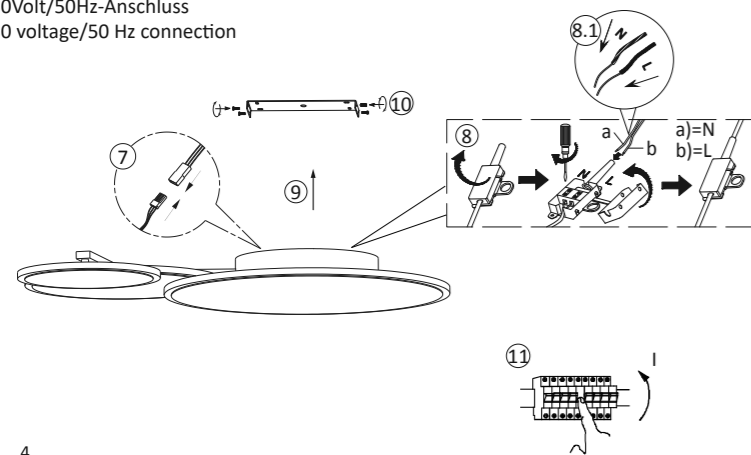

3 | Fernbedienung / remote control

Siehe Q-Fernbedienungsanleitung
See Q-remote control manual

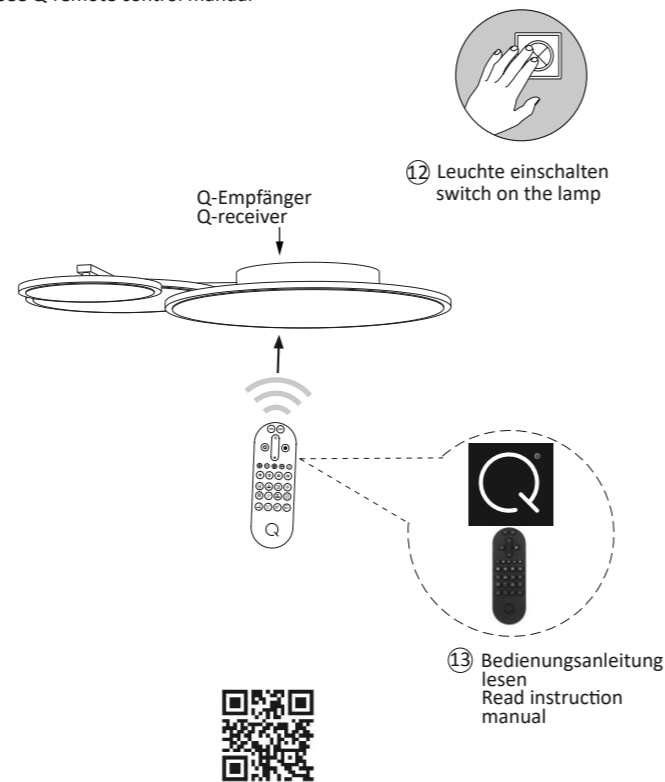

Reset

Zur Einbindung in ein ZigBee Netzwerk, stellen Sie die Leuchte auf Werkseinstellungen zurück.

To integrate the lamp into a ZigBee network, reset the lamp to the factory setting.

5x on/off

