

INSTRUCTION MANUAL

(NL) Gebruikte symbolen

(GB) Safety Precautions / (FR) Symboles utilisés / (DE) Verwendete Symbole / (PL) Stosowane symbole / (NO) Brukte symboler / (DK) Brugte symboler / (SE) Använda symboler / (FI) Käytetyt symbolit / (IT) Simboli usati / (ES) Símbolos empleados / (CZ) Použité symboly / (PT) Símbolos utilizados / (GR) Χρησιμοποιούμενα σύμβολα



Jeany SL Black 1-Phase Ar111

107182

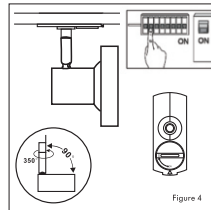
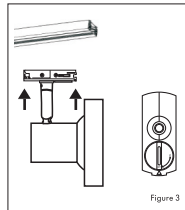
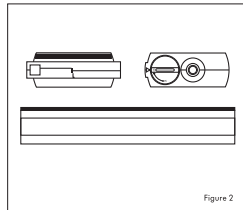
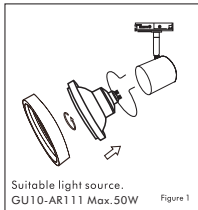
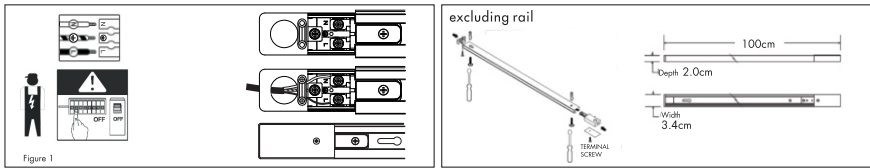
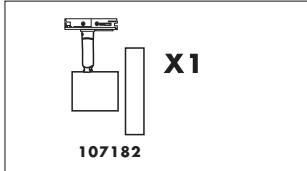

TO INSTALL:

- 1) Ensure that the adaptor's **Line** is facing with the **Line** in the track rail.
- 2) Turn the switch on the adaptor to "OFF". Then push the adaptor into the track.
- 3) Then turn the switch on the adaptor to "ON".

TO REMOVE: Turn off the switch to unlock the adaptor on the track rail.
Removing the adaptor by reversing the above sequence

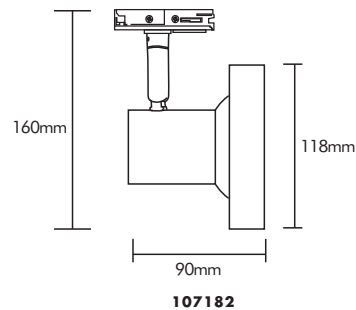

SAFETY INSTRUCTION

Please study the instruction manual and below information carefully before installing or using this product. Please keep this user manual for further reference

1. The luminaires may only be installed by authorized and qualified technicians according to the valid regulations for electrical installation.
2. Maintenance of the luminaires is limited to their surfaces. During maintenance no moisture can come into contact with any areas of the terminal connections or voltage control parts.
3. The electrical supply must be switched off at the outset, preferably by means of a switch in the distribution box, before any installation, maintenance or repair work is undertaken.
4. Exterior lighting must not be installed during rain.
5. Take account of the minimal separation distance from other objects and the room required around the fitting.
6. If in any doubt, consult a professional, taking local installation requirements into account. Some countries stipulate that lighting may be installed only by registered installers.
7. Clamping screws in electrical connections must be adequately tightened. This is particularly the case with 12V low voltage conductors.
8. Clean with a clean, dry cloth or brush, use no solvents or abrasives. Avoid dampness on all electrical components
9. Take account of all available technical information.
10. Meaning of symbols:

- This icon indicates the level of water-proof and dust-proof
- Protection Class I: the fitting must be earthed
- Protection Class II: the fitting is doubled insulated and does not require earthing
- Protection Class III: the fitting is low voltage
- Minimum distance from lighted objects (meters)
- The type of lamp and maximum size and wattage indicated in each lighting unit must not be exceeded; different items require different kind of light sources with different bulb icons
- The armature is designed to work only with the indicated voltage. Different items require different working voltage.
- The luminaire can be used in combination with a dimmer
- The luminaire can be dimmed by wall switch
- The reference light angle and light space of the luminaire
- This luminaire cannot be disposed together with normal domestic waste in standard rubbish can, but you have to bring it to a staging area for electrical waste

11. Take note of the symbols when connecting wires:

	(DE)	(GB)	(FR)	(NL)	(PL)	(NO)	(DK)
	Stromführender Leiter	Live conductor	Conducteur	Spanningvoerende draad	Przewód prądowy	Strømførende leder	Strømførende leder
	Schutzleiter	Earth conductor	Conducteur de protection (terre)	Aardkabel	Przewód uziemiający	Jordledningen	Jordledningen
	Neutralleiter	Neutral conductor	Conducteur neutre	Nulleider	Przewód zerowy	Neutrallleder	Neutrallleder
	(SE)	(FI)	(IT)	(ES)	(CZ)	(PT)	(GR)
	Strömförande ledare	Virtajohdin	Conduttore sotto tensione	Conductor de corriente	Vodič pod napětím	Condutor vivo	Ρευματοφόρος αγωγός
	Skyddsledare	Suojajohdin	Conduttore di terra	Conductor de protección	Ochranný vodič	Condutor de terra	Αγωγός γείωσης
	Neutrallledare	Nollajohdin	Conduttore neutro	Conductor neutro	Neutrální vodič	Condutor neutro	Ουδέτερος αγωγός