

INSTRUCTION MANUAL

(NL) Gebruikte symbolen

(GB) Safety Precautions / (FR) Symboles utilisés / (DE) Verwendete Symbole / (PL) Stosowane symbole / (NO) Brukte symboler / (DK) Brugte symboler / (SE) Använda symboler / (FI) Käytetyt symbolit / (IT) Simboli usati / (ES) Símbolos empleados / (CZ) Použité symboly / (PT) Símbolos utilizados / (GR) Χρησιμοποιούμενα σύμβολα



220-240V~
50Hz



IP20



Sofia Fan White Smart

106953

CCT dim(3500-2700-3000K)

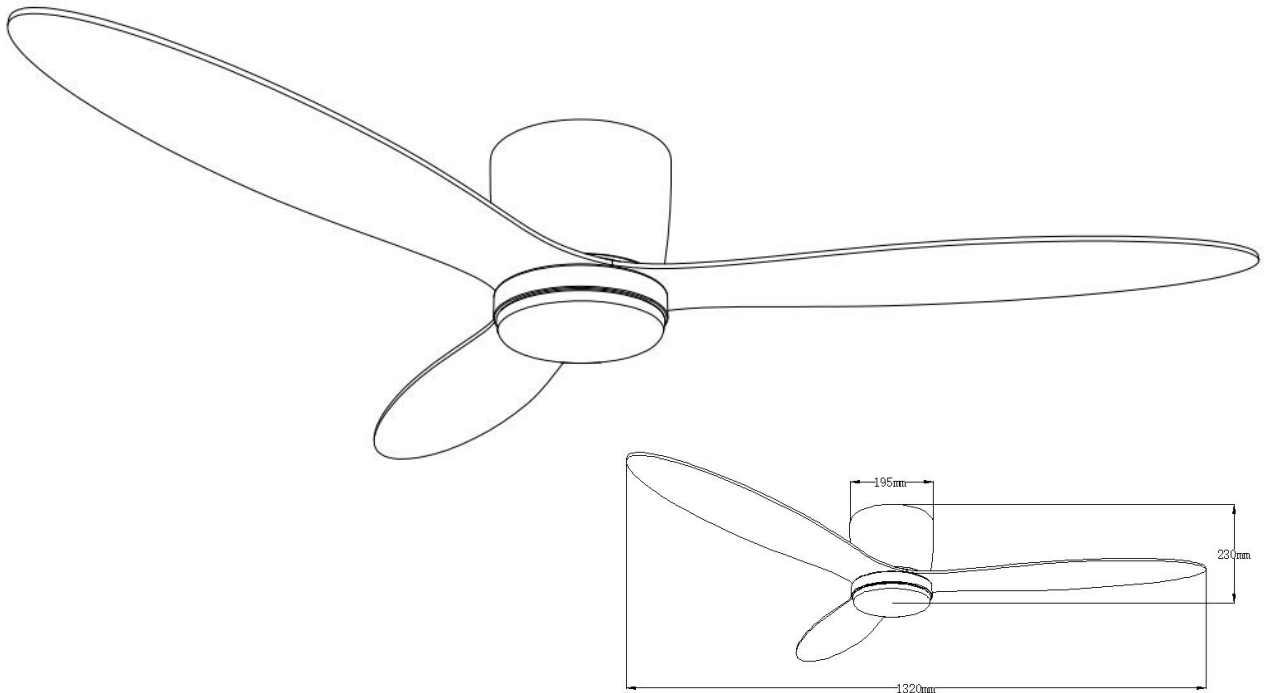

Speed (rpm)			Sound (db)			Application		Function			Motor	
Max rpm	Med rpm	Min rpm	db Max rpm	db Med rpm	db Min rpm	Circulating Air m ³ /min	Max Surface in m ²	Speed Setting	Timer Function yes/no	Seasonal profiles winter/summer/both	Fan Motor AC/DC	Watt Motor
230	178	80	61.21	45	35	164.25	Lamp 15-20m ² FAN 20m ²	5	yes	both	DC	38W



Warnings:

Do not poke any objects or fingers through the protective screens

Do not place any objects, such as clothing, on the device

Be careful with long hair. These can be sucked in by the air flow, keep sufficient distance.

INSTRUCTION MANUAL

106953

Sofia Fan White Smart

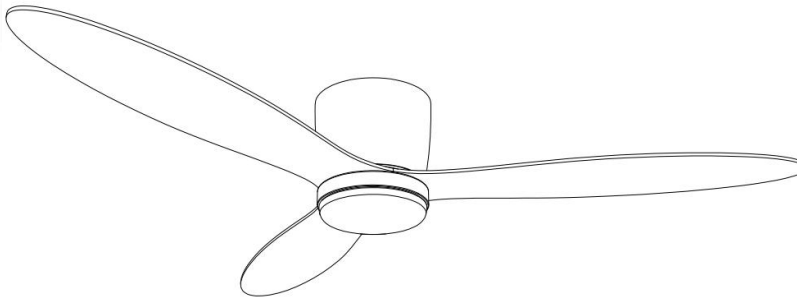

Ceiling fan lamp
incl. LED QL7001024
1700lm Module
800lm Lamp
16W LED Module
16W Lamp / 40W Fan
220-240V~50Hz
3500-2700-3000K
CRI>80
17000h
8500 ON/OFF

<p>(DE) Dieses Produkt enthält eine Lichtquelle der Energieeffizienzklasse F (EN) This product contains a light source of energy efficiency class F (FR) Ce produit comprend une source de lumière de classe d'efficacité énergétique F (NL) Dit product bevat een lichtbron van energie-efficiëntieklasse F (PL) Produkt ten zawiera źródło światła o klasie efektywności energetycznej F (NO) Dette produktet inneholder en lyskilde i energieeffektivitetsklasse F (DK) Dette produkt indeholder en lyskilde af energieeffektklasse F (SE) Denna produkt innehåller en ljuskälla i energieffektivitetsklass F (FI) Tämä tuote sisältää energiatehokkuusluokan F valonlähteen (IT) Questo prodotto contiene una sorgente luminosa della classe di efficienza energetica F (ES) Este producto contiene una fuente de luz de la clase de eficiencia energética F (CZ) Tento výrobek obsahuje světelný zdroj třídy energetické účinnosti F (PT) Este produto contém uma fonte de luz da classe de eficiência energética F (GR) Αυτό το προϊόν περιέχει μια φωτεινή πηγή ενεργειακής απόδοσης κλάσης F (SK) Tento výrobok obsahuje zdroj svetla triedy energetickej efektivity F</p>	QR	EAN
		<p>106953 8718881152597</p>

	<p>(DE) Durch einen Fachmann austauschbare Lichtquelle (nur LED) (EN) Replaceable (LED only) light source by a professional. (FR) Source de lumière remplaçable (LED uniquement) par un professionnel. (NL) Lichtbron (alleen led) te vervangen door een professional. (PL) Wymienne (tylko LED) źródło światła wykonane przez profesjonalistę. (NO) Utskiftbar (kun LED) lyskilde av en profesjonell. (DK) Udskiftelig lyskilde (kun LED), udskiftes af en elektriker. (SE) Ljuskälla (endast LED) utbytbar genom fackman. (FI) Ammattilainen voi vaihtaa vaihdettavan (vain LED) valonlähteen. (IT) Sorgente luminosa (solo LED) sostituibile da un professionista. (ES) Fuente de luz (solo LED) sustituible por un profesional. (CZ) Vyměnitelný (pouze LED) světelný zdroj odborníkem. (PT) Luz LED (apenas LED) substituível por um profissional. (GR) Η πηγή φωτός (μόνο LED) να αντικαθίσταται από επαγγελματία. (SK) Zdroj svetla (iba LED) vymeniteľný prostredníctvom odborníka.</p>
--	---

	<p>(DE) Durch einen Fachmann austauschbares Betriebsgerät. (EN) Replaceable control gear by a professional. (FR) Contrôleur remplaçable par un professionnel. (NL) Voorschakelapparatuur te vervangen door een professional. (PL) Wymienny układ sterujący przez profesjonalistę. (NO) Utskiftbar kontrollutstyr av en profesjonell. (DK) Udskiftelig igangsætter, udskiftes af en elektriker. (SE) Styrdon utbytbar genom fackman. (FI) Ammattilainen voi vaihtaa vaihdettavat ohjauslaitteet. (IT) Dispositivo di controllo sostituibile da un professionista. (ES) Dispositivo de control sustituible por un profesional. (CZ) Vyměnitelný předřadník odborníkem. (PT) Dispositivo de controlo substituível por um profissional. (GR) Ο εξοπλισμός ελέγχου να αντικαθίσταται από επαγγελματία. (SK) Predradník vymeniteľný prostredníctvom odborníka.</p>
--	--

Remote Control Instruction

Simplified Declaration of Conformity:

Hereby, FittinQ BV declares that the radio equipment type [Ceiling Fan Controller RF433] is in compliance with Directive 2014/53/EU.

The full text of the EU declaration of conformity is available at the following internet address: www.qazqa.nl

This ceiling fan can be installed with remote control, but make sure you know how to install the device in safe way or consult licensed electrician

Warranty may be affected if you install the improper remote control or install it in improper way.

(1) WIRING SCHEMATIC DIAGRAM FOR RECEIVER

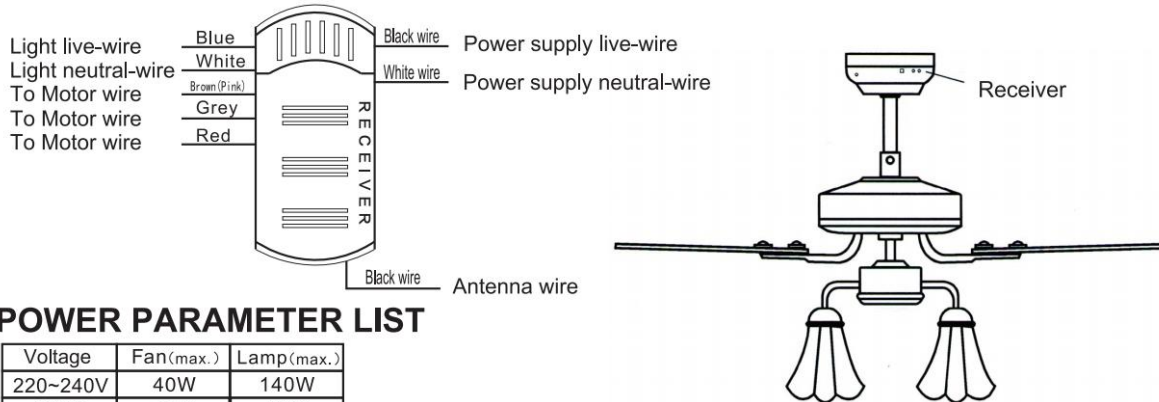

POWER PARAMETER LIST

Voltage	Fan(max.)	Lamp(max.)
220~240V	40W	140W
120V	40W	55W

Adopt RF wireless digit emission technique, biunique controlled, coincident code rate is less than one millionth. (Emitter and receiver must be sent back to factory for maintenance if damaged.)

Receiver can be controlled by any angles of the emitter in prescriptive space, unrestricted by direction. With the memory function, the controller can save the status (light and direction) while the supply power OFF and resume to the original after reload the power supply.

(2) FUNCTION INSTRUCTION OF EMITTER

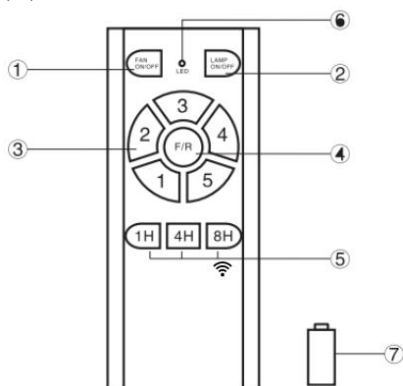

- ① ON/OFF the fan
- ② ON/OFF the light
- ③ Speed of the fan (① low speed ---- ⑤ high speed)
- ④ Direction of the fan (reverse switch)
- ⑤ Timing control of the fan (8H button is also with function of WIFI connection)
- ⑥ LED indicated light
- ⑦ 1X23A 12V battery should be used in emitter

Notes:

- 1) Power on, the light on with 3500K
- 2) Push LIGHT ON/OFF button the 1st time, the light off
- 3) Push LIGHT ON/OFF button the 2nd time, the light on with 2700K
- 4) Push LIGHT ON/OFF button the 3rd time, the light off
- 5) Push LIGHT ON/OFF button the 4th time, the light on with 3000K.
- 6) Push LIGHT ON/OFF button the 5th time, the light off

(3) KINDLY REMINDERS:

1. Learning code matching mode is used between emitter and receiver. Turn "ON" the supply power within 30 seconds and press the emitter's "FAN ON/OFF" button for 5 seconds, it can load normally after hearing a long sound "bee", which means learning successfully and it can work normally. (PS: Learning mode is not accepted after turn "ON" the supply power for 30 seconds)
2. When the emitter cannot control the receiver, please check the battery switch touching normally or not, correction of the positive and negative, full or empty of the power.
3. When the emitter cannot control the receiver, please check is there any existence of similar remote controlled products nearby, then check whether they work, because remote controlled product with the same frequency will disturb each other.
4. Low voltage of battery will affect the sensitivity of the emitter and the signal reception accordingly (the indicated light will flash out its warning when the battery get low voltage), must replace if the battery is getting low voltage.
5. Please take out the battery from the emitter when leaving unused for long time.
6. The maximum load of lighting see the above "POWER PARAMETER LIST"
PS: please connect the ground wire correctly, otherwise it may cause the light micro-light or flash
7. When installing the fan, the fan ceiling cover don't press the antenna (or other wire), it is easy to breakdown the wire and short-circuited.

Type number remote: RF433
RF frequency range: 433.92MHZ
Transmit power: 7.75dBm
Coverage area: 15m



WiFi Connect Instruction

1. Installation

1) You can scan the QR below to download the Smart Life app.



You can also search "Smart Life" in the major application markets to install the app.

2) Click "...", select "Open in Browser", and then click "Download".

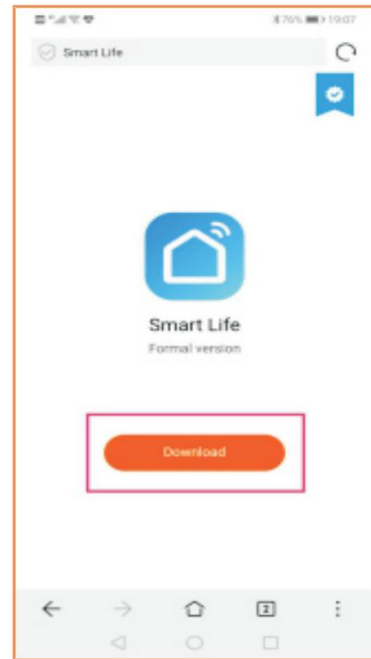
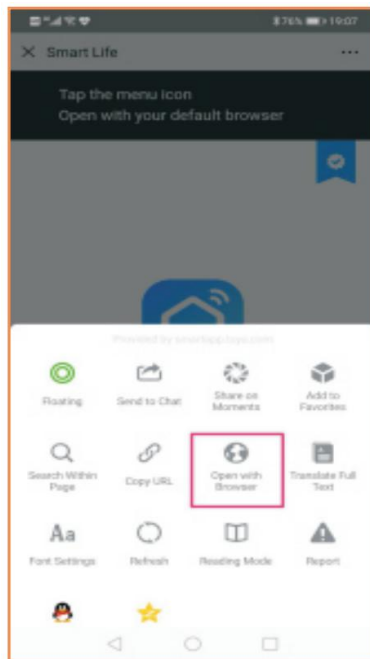
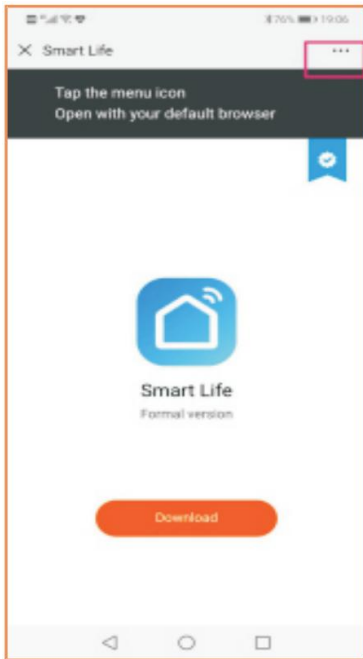

3) Click "Install" after the installation is successful open the software.

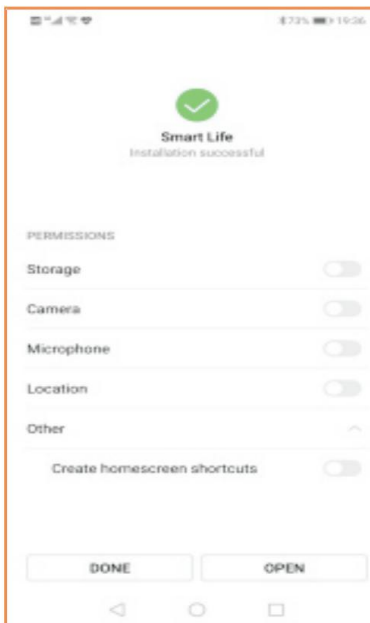
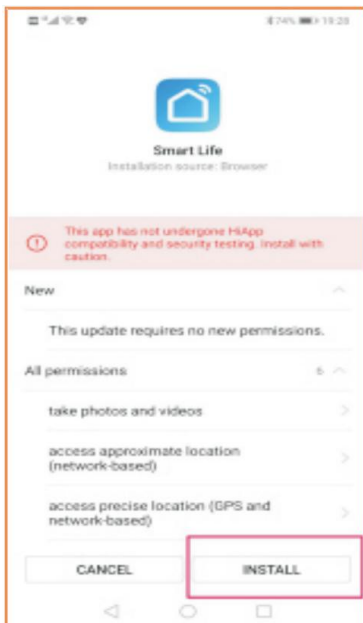

2. Register an account and log in

If you do not have an app account, you may choose to register or log in by authentication code.

- 1) Click "Register" to go to the Smart Life privacy policy page. Click "Agree" to proceed to the registration page.

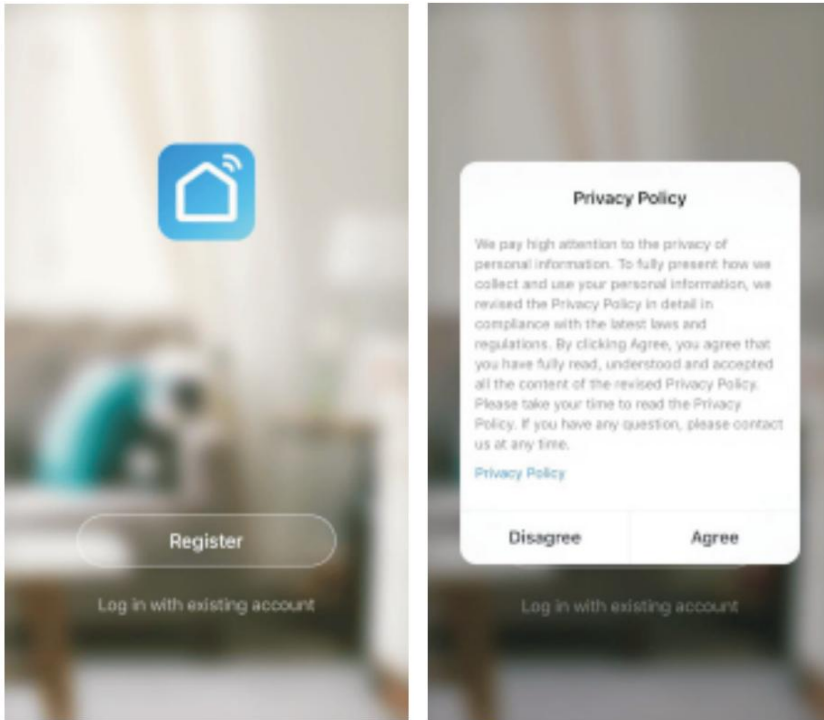

- 2) The system will identify automatically the country/region you are in, or you may choose to select manually a country/region. Enter your mobile phone number or email and click "Get authentication code". Enter the authentication code you received. Then enter the password and click "completed" to complete registration.

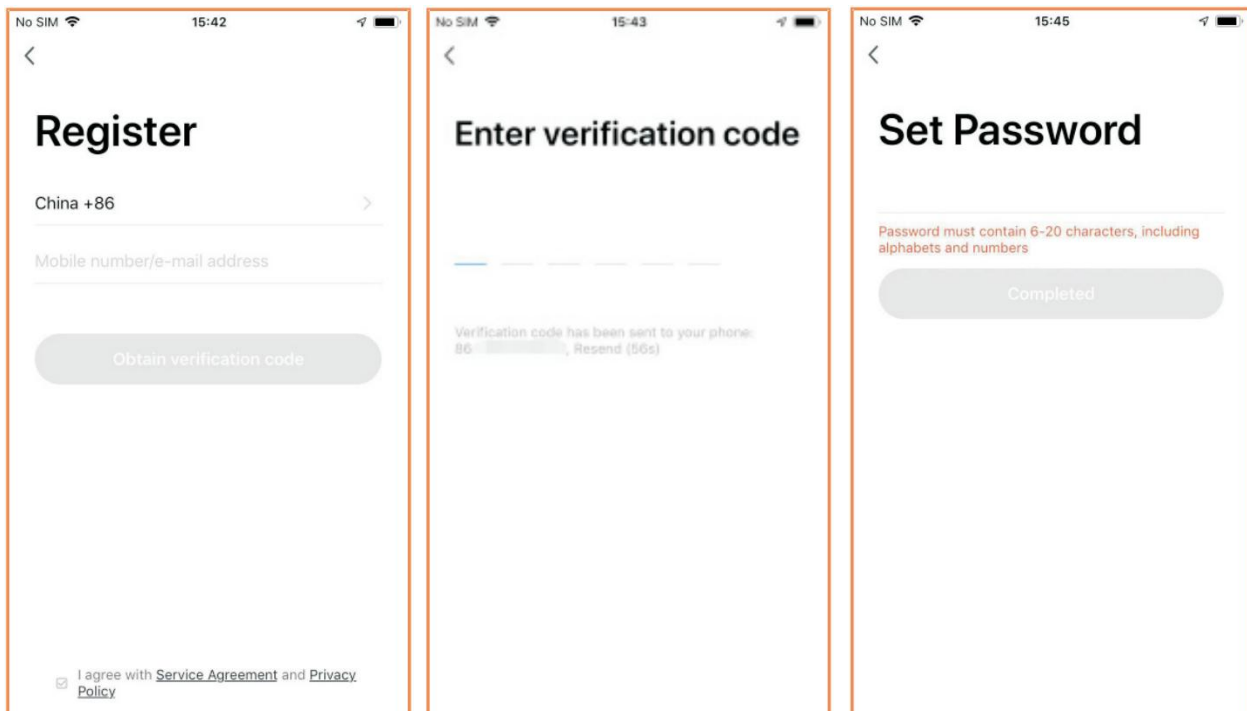

3) Account ID + Password Login

Enter the mobile phone number or email you have registered and enter the password in to log in.

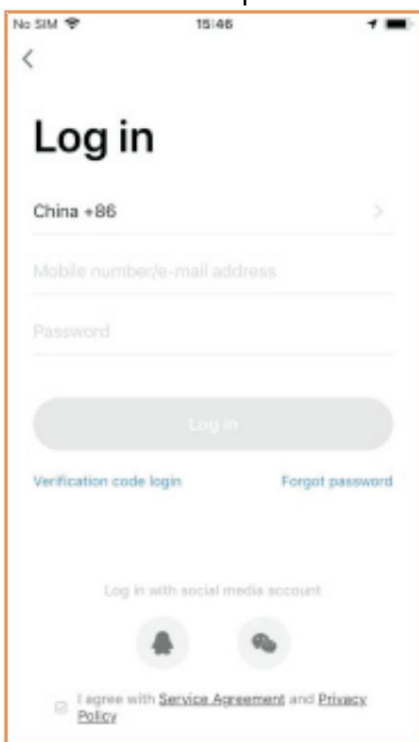

4) Verification Code Login

(1) Click "Verification code login" in Fig.1 to go to the next page.

(2) The system will identify automatically the country/region you are in, or you may also choose to select manually a country/region.

(3) Enter your mobile phone number or email and click "Obtain authentication code", as show in Fig.2.

(4) Enter the authentication code in the text message or email to log in, as show in Fig.3.

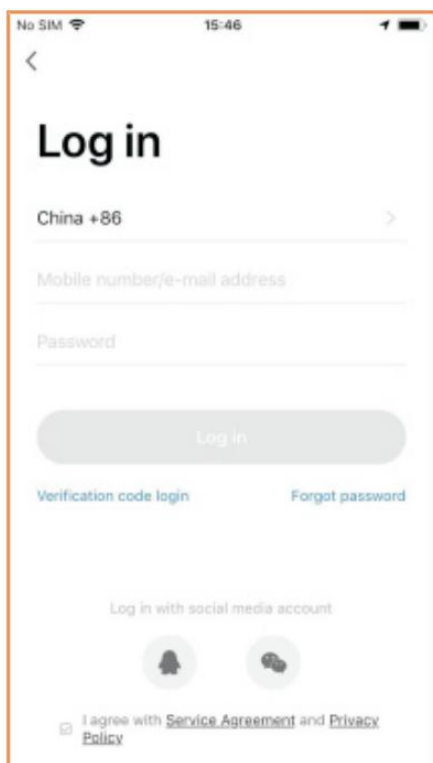

Fig.1

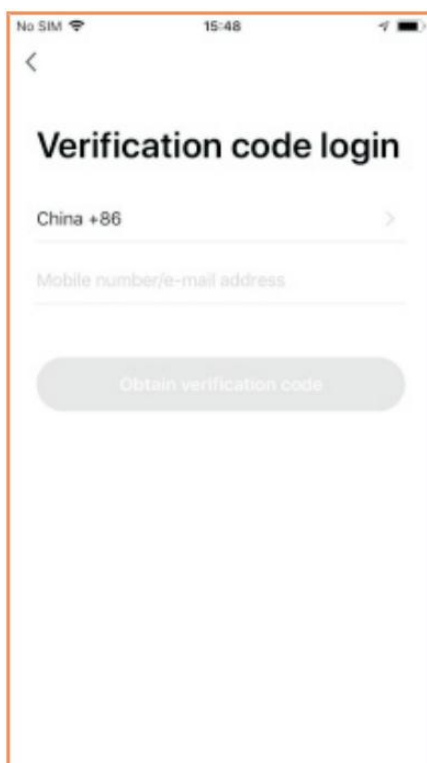

Fig 2



Fig.3

3. WIFI connect

- 1) First ensure that wifi can be used normally.
- 2) Click "Add Device", first select "Home Appliances II" then select "Fan".

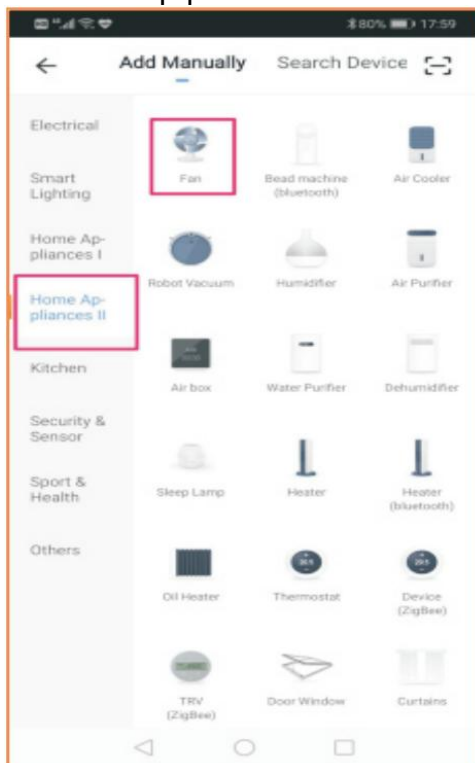
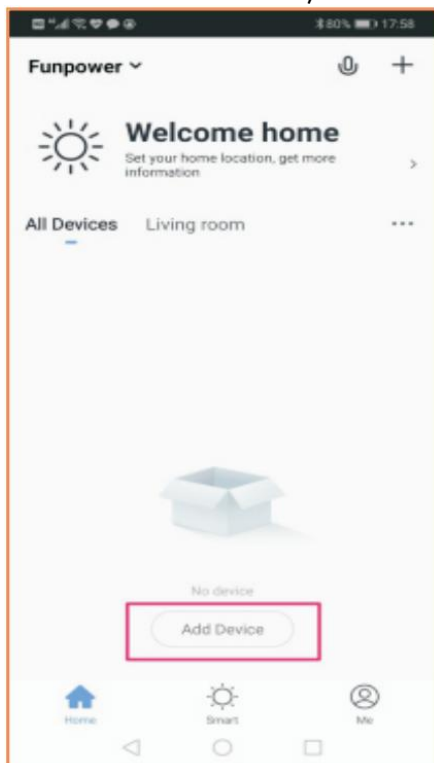

- 3) Press and hold the "8H" button of the emitter for more than 5 seconds. Wait until the ceiling fan receiver hears "BeeBee" continuously.

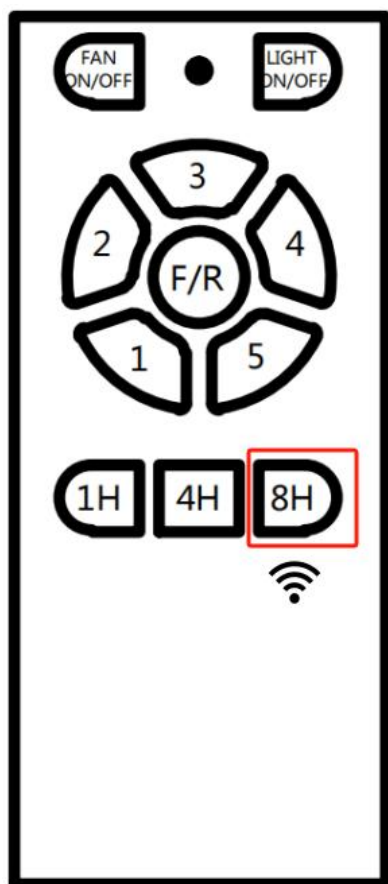

4) Select the correct wifi source, then enter the wifi password and click "Confirm" to wait for the connection.

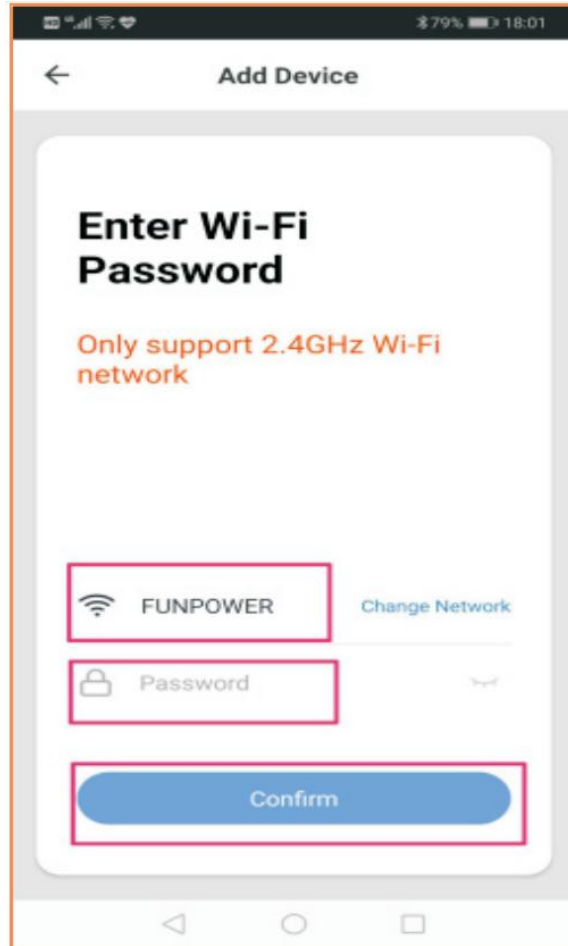
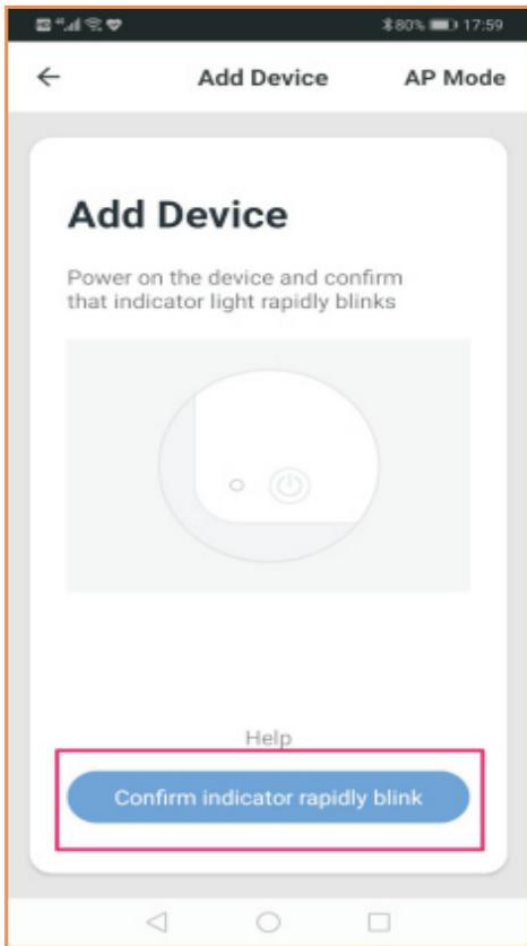

5) Wait for the connection to succeed.

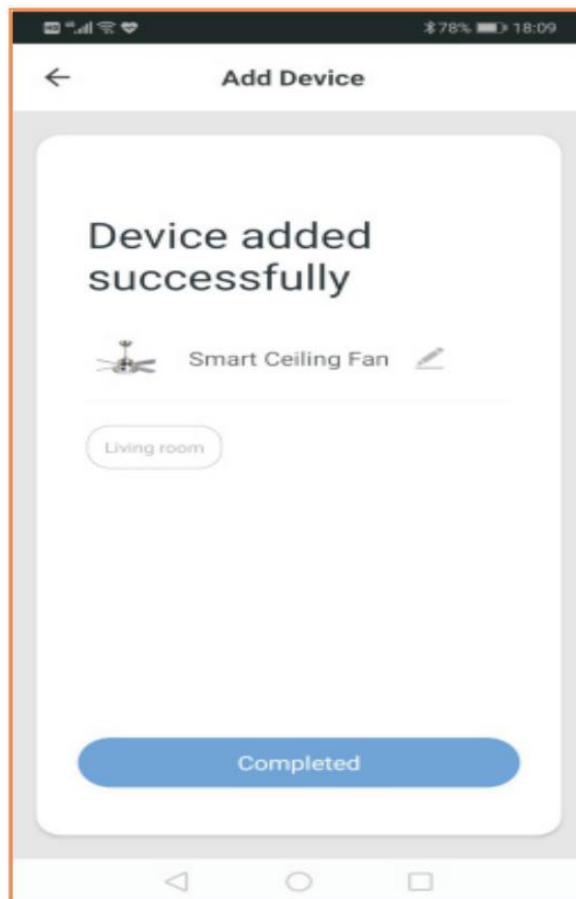
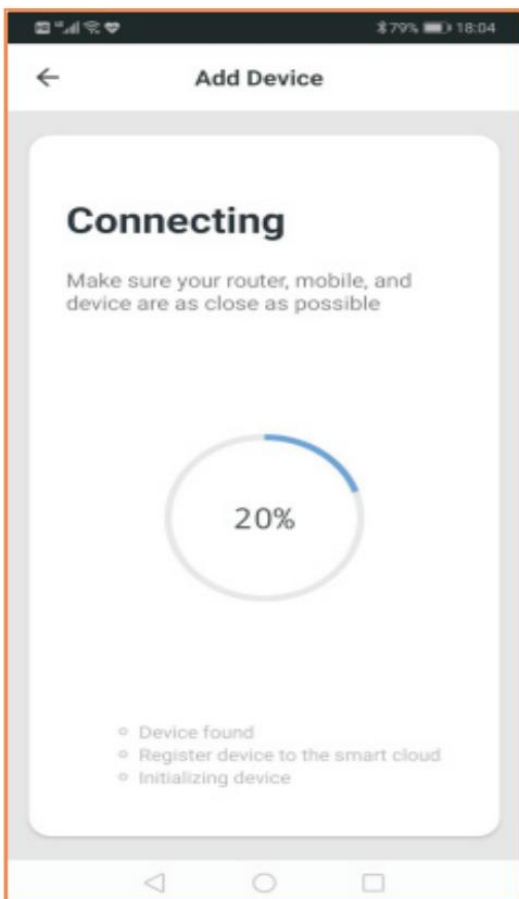

4. Multiple members control the same device or multiple devices

1) You can enter the single device control page in the app, click on the upper right corner "⌵" to enter more functions, click on "Share Device" - "Add Share", enter the phone number of the other user and click "Finish" to share the device with other members

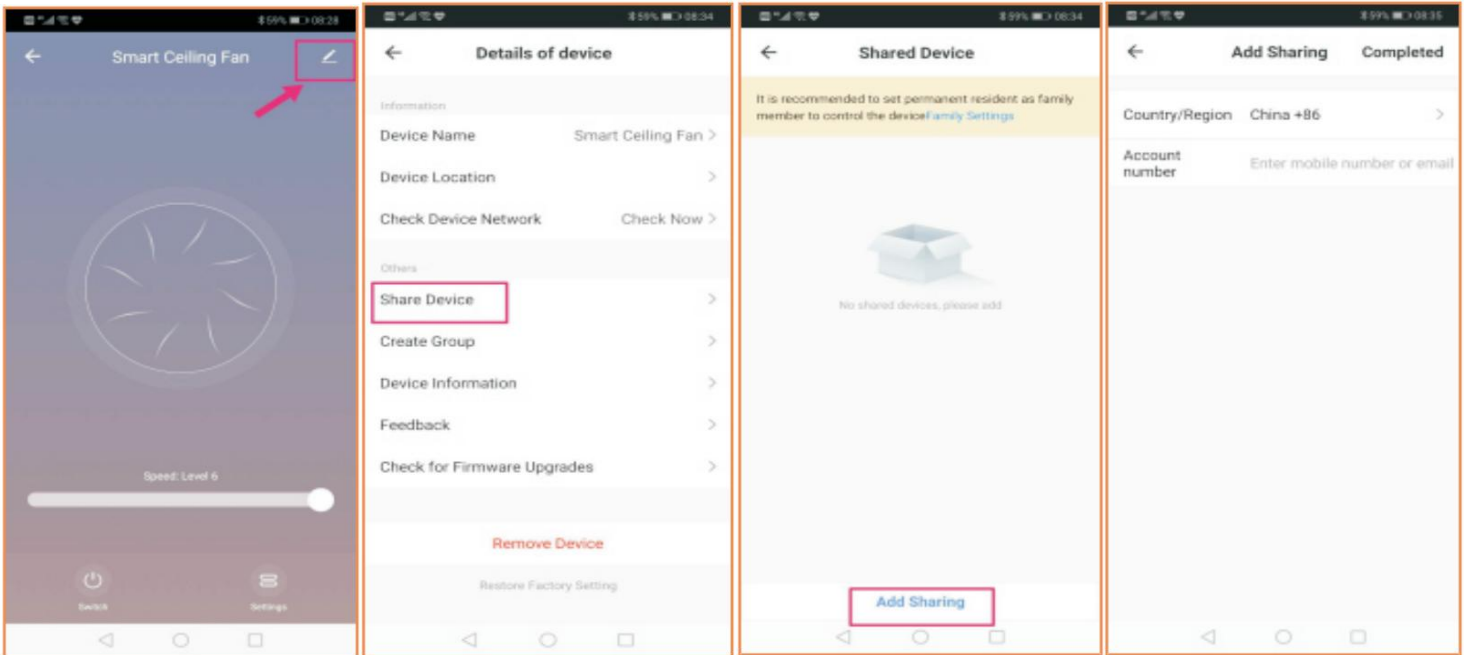

Note: The above method requires the other users to have an APP account.

2) The simplest way to share is to use a public account to log in.

5. For more information, go to the "Me" - "Help Center" in the app to learn

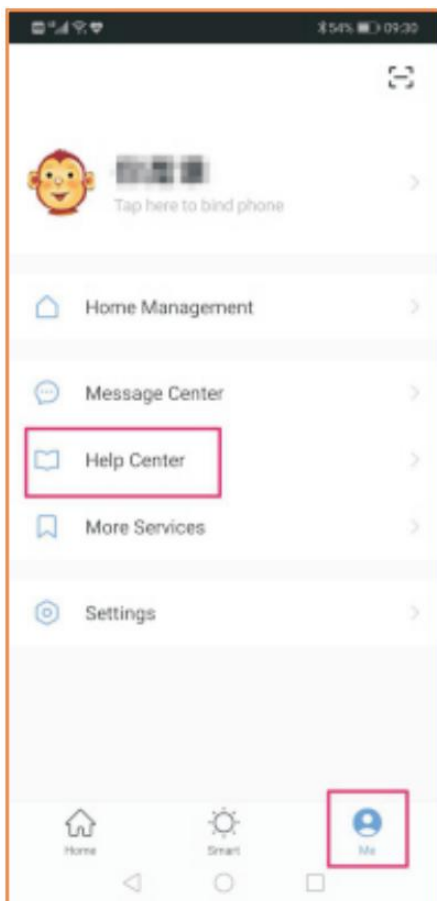

1. Warning symbols

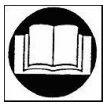

Read the instructions



Caution



Lamp

2. General Safety Instructions



Read this instruction manual thoroughly before using the appliance and save it for future reference and if necessary pass the instruction manual on to a third party.

WARNING: When using electrical appliance, basic safety precautions should always be followed to reduce the risk of fire, electrical shock and personal injury.

1) General

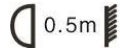
- Before carrying out any work on the fan, disconnect it from the electrical supply!
 - Check if the electrical specifications of this appliance are compatible with your installation. The supplier accepts no responsibility for any physical injury or material damage resulting from incorrect use or installation of this fan. If you have the slightest doubt, please contact electrician.
 - Unauthorized use and technical modifications to the appliance can lead to danger to life and health.
 - This appliance can be used by children aged from 8 years and above and persons with reduced physical, sensory or mental capabilities or lack of experience and knowledge if they have been given supervision or instruction concerning use of the appliance in a safe way and understand the hazards involved. Children shall not play with the appliance. Cleaning and user maintenance shall not be made by children without supervision
 - Children should be supervised to ensure that they do not play with the appliance.
 - This appliance is for indoor use only.
 - Means for disconnection must be incorporated in the fixed wiring in accordance with the wiring rules.
 - Never install the appliance in a moist or wet room.
 - Be careful when working near the rotating blades. The fan should be installed at least a height of 2.3m
 - Before pushing the reversible slide switch, it is necessary to stop the action of the blades by turning off the fan
 - Don't place your arm or other object in the path of the blades, when the fan is operating.
 -  Always maintain the minimum distance between the lamp and any inflammable material (curtains, wall etc), as indicated on the pictogram
 - Means for all poles disconnection having a contact separation that provide full disconnection under over voltage category III conditions must be incorporated in the fixed wiring in accordance with national wiring rules.
 - Power supply wire from ceiling needs 1.5 sq mm wire
 - Regarding the method of the cable connection, how to assembly and the bulb type reference of a luminaire, thanks to refer to the section "INSTALLATION"
 - Warning: Before obtaining access to terminals, all supply circuits must be disconnected.
- "5. Appliance specification".
- Warning: Before obtaining access to terminals, all supply circuits must be disconnected.

2) Electrical safety

The appliance should be installed by authorized electrician only acc. to national wiring rules.

3) Specific Safety Rules

The fan is to be installed so that the blades are more than 2.3 m above the floor

4) Environmental protection CAUTION!

Electrical products must not be thrown out with domestic waste. They must be taken to a communal collecting point for environmentally friendly disposal in accordance with local regulations. Contact your local authorities or stockist for advice on recycling. The packaging material is recyclable. Dispose of the packaging in an environmentally friendly manner and make it available for the recyclable material collection-service.



5) Appliance specifications

TECHNICAL CHARACTERISTICS	
Rated voltage	220-240 V
Rated frequency	50 Hz
Rated wattage	40 W
Bulb rating	1x16W. LED
Ambient operating temperature	25 °C
Protection class	I
IP number	IP20
Protective shields	N/A

6) The ceiling fan (element)

PARTS DESCRIPTION

1. Mounting bracket
2. Receiver
3. Remote
4. Motor assembly
5. Blades
6. Light kit plate
7. Light kit
8. Shade

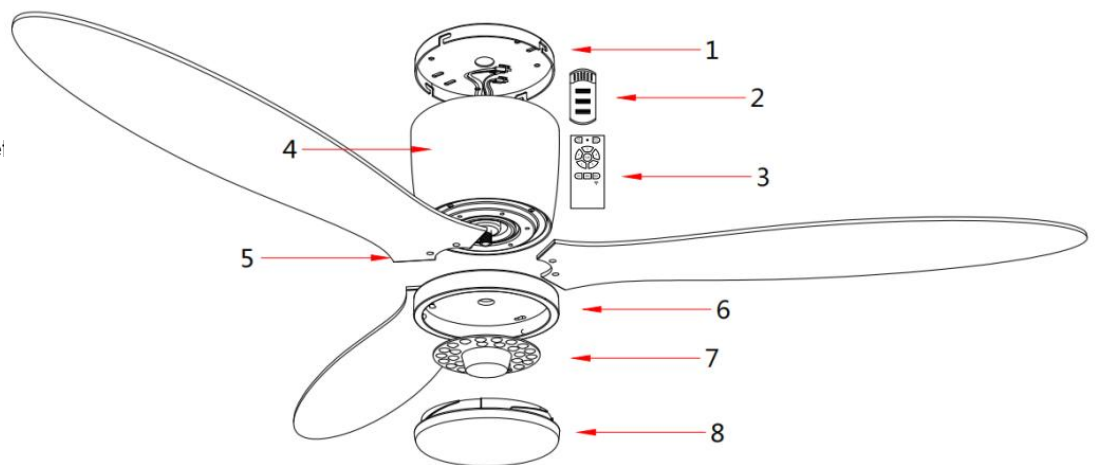

7) Installation of the ceiling fan

1. Cut off the power supply and install the mounting plate by screws. (Fig.1)
2. Install the motor with the mounting plate by screws.(Fig.2)
3. Install the housing.(Fig.3)
4. Install the blades on the motor by screws (Fig.4)
5. Assembly the LED light to the light kit fixing bracket by the screws(Fig.5)
6. Connect the LED light kit by male & female plug.(Fig.6)
7. Assembly the shade to the light plate by rotating clockwise when assembling. (Fig.7)
8. Now, the fan is completed. Please turn on the power supply and use remote to try all the functions. (Fig.8)

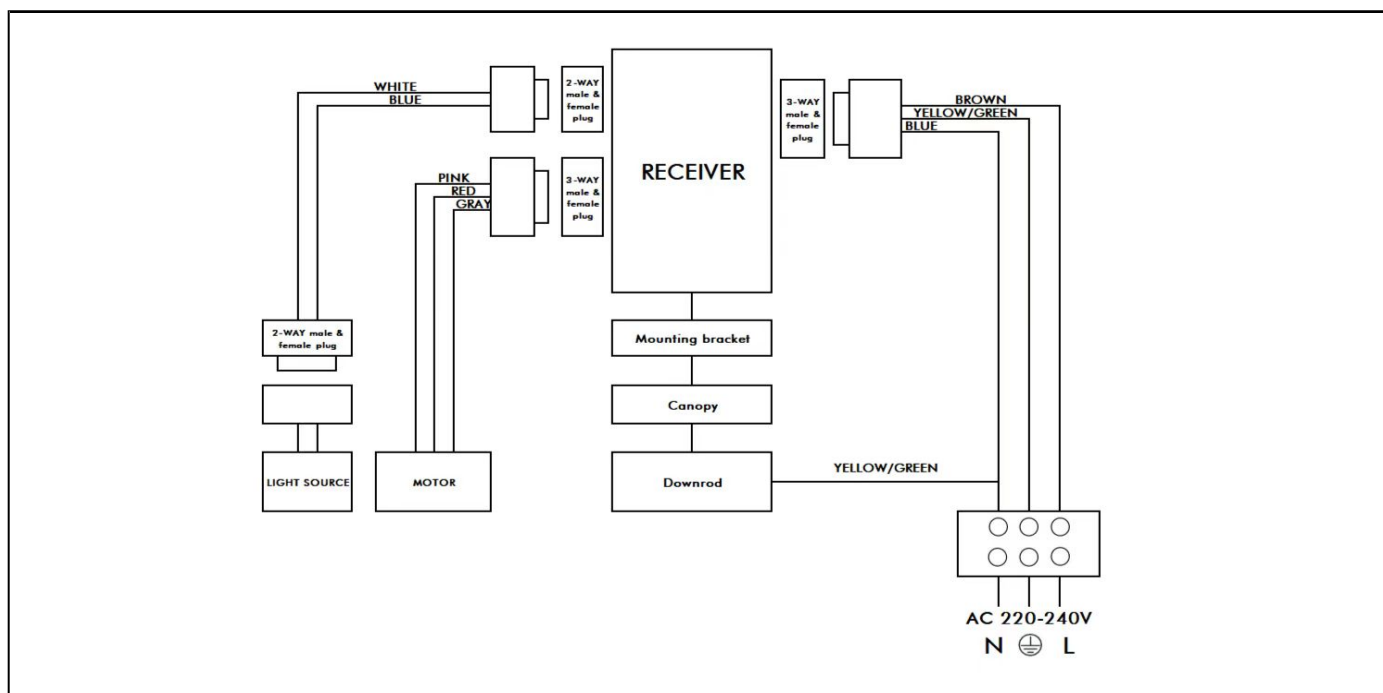
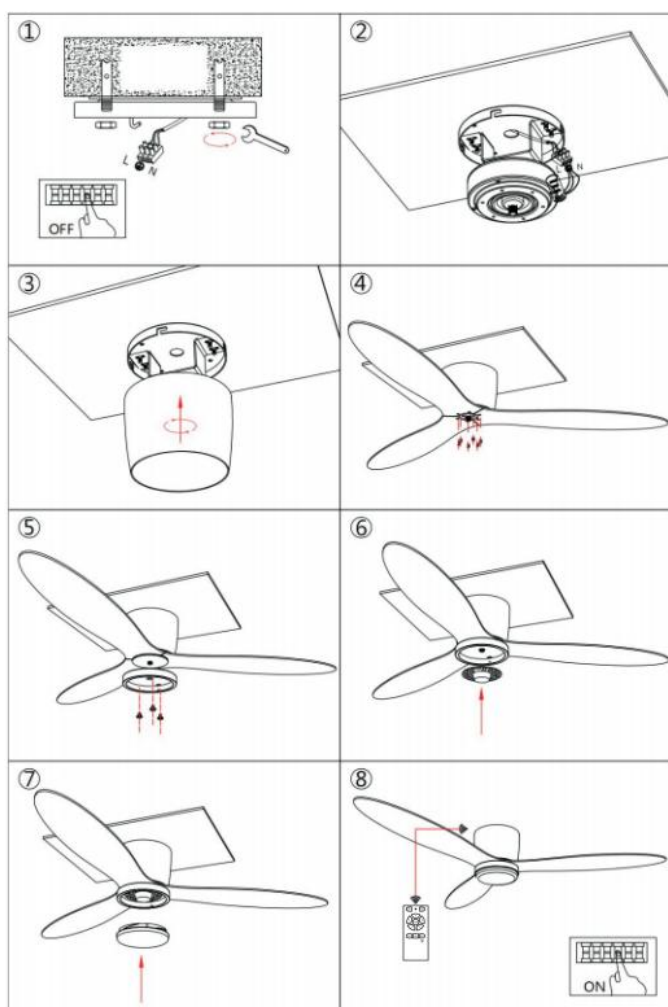

If the fan or light kit is PARTIALLY pre-assembled, you can skip the assembly procedures to next step

8) How to use

- Direction switch on the fan 's remote.(FORWARD and REVERSE switch)
- Down for summer make the air movement directly from ceiling.
- UP for winter, to circulate the warm air generated by heater to floor.



9) Disconnect from mains before maintenance or cleaning.

Do not use a wet sponge to clean the appliance.

1. Before conducting any cleaning or maintenance work, disconnect the lamp from the electrical supply and wait until it cools down
2. No abrasive products, solvents, detergent or any other liquid may be used to clean the fan or lamp
3. Be sure the power is off when you clean the fan
4. Don't clean the motor, switch house and other electric parts of the fan with water in order to avoid short circuit

10) Trouble shooting

TROUBLE	PROBABLE CAUSES	SUGGESTED REMEDY
1. Fan will not start	A/ Fuse or circuit breaker blown. B/ Loose power line connections to the fan. C/ Speed controller not in correct position.	A/ Check main and branch circuit fuses or circuit breakers. B/ Check line wire connections to fan C/ Check speed controller's position.
2. Fan sound noisy	A/ Top canopy touching ceiling. B/ Loose fan blade screws. C/ Ceiling fan not secured against ceiling. D/ Incorrect speed controller.	A/ Lower Canopy from ceiling to ensure minimum 3 mm clearance. B/ Re-tighten all screws on fan blades but never over-tighten. C/ Re-tighten all screws in the hanging bracket or plate. D/ Change the controller to the one supplied.
3. Mechanical Noise	A/ Allow at least for 8 hours settling-in period.	
4. Fan Wobbles	A/ Fan blades are not horizontal to ceiling. B/ Blade screws are loose.	A/ Measure from ceiling to tip of blades, then rotate fan so all blades are checked for equal height from ceiling (not adjustments may be made by slight pressure up or down on blade holders). Make sure all screws are securely fastened.

DYNAMIC BLADE BALANCE KIT

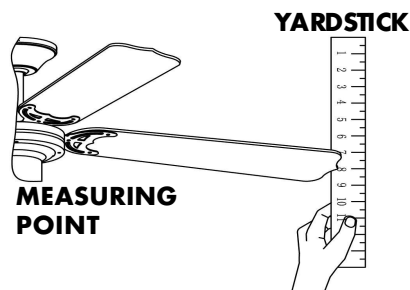

P.13

PREFACE

Your ceiling fan may sometimes have wobble problem when operate due to irregularity in blades or the blade holder. Also, improper assembly in the mounting system may cause some additional problem also bearing crooked. The following procedure to remedy such problem is strongly recommended by us from our past experience in handling the wobble problem.

Dynamic blade balancing kit for ceiling fans

1. **M**ake sure that all blade are firmly screwed into the blade holder
2. **M**ake sure that all blades are firmly secured the flywheel and check pitch of blade holders all must be the same
3. **B**y looking up the fan from below, check and be certain that none of the blade holders are bent so that none of the blade is out of position. A correction can be made by very gently bending the blade holder back into position
4. **B**y the simple use of a household yardstick blade tracking can be checked, out the yardstick up against the ceiling vertically and even with the outside leading edge of a blade. Note the distance of the edges of the blade to the ceiling; carefully turn the blade slowly by hand to check the remaining blades. If blade is not in alignment, the blade holder may be gently bent up or down to be in line with the other blades

If by following all the steps and the wobble problem is not solved, a dynamic balancing need to be done by the use of the balancing kit. Follow the procedure listed below:

- Turn the fan on and adjust the speed control (usually high speed) setting to the speed, which creates to greatest wobble.
- Turn the fan off; select on blade place the balance clip on it. Halfway between the blade holder and the blade up on the rear edge of the blade.
- Turn the fan on, watch to see of the wobble is improved or worse. Then, turn the fan off again and move the clip to another blade and test again. Repeat this process with all blades and then note that blade which is the most improved.
- Move the clip back to the blade, which showed the most improvement. Move the clip inward and outward on this blade and operate the fan to find the position where the clip gives the most improvement
- Next remove the clip and install a balancing weight to the top of the blade along the centerline near the point where the clip was positioned.

Caution: stay clear of the blades if the clip for any reason is not secured, injury could result

12) Others

Have your product repaired by a qualified person

This electric product is in accordance with the relevant safety requirements. Repairs should only be carried out by qualified persons using original spare parts; otherwise this may result in considerable danger to the user. This appliance can be used by children aged from 8 years and above if they have been given supervision or instruction concerning use of the appliance in a safe way and if they understand the hazards involved. Cleaning and user maintenance shall not be made by children unless they are older than 8 and supervised. Keep the appliance and its cord out of reach of children aged less than 8 years.

Please contact the store which you bought the product for after sale services if **question**

This appliance can be used by children aged from 8 years and above if they have been given supervision or instruction concerning use of the appliance in a safe way and if they understand the hazards involved. Cleaning and user maintenance shall not be made by children unless they are older than 8 and supervised. Keep the appliance and its cord out of reach of children aged less than 8 years.

Appliances can be used by persons with reduced physical, sensory or mental capabilities or lack of experience and knowledge if they have been given supervision or instruction concerning use of the appliance in a safe way and understand the hazards involved. Children shall not play with the appliance.

Please contact the store which you bought the product for after sale services if question

Information requirements regarding the eco-design			
Description	Symbol	Value	Unit
Maximum fan flow rate	<i>F</i>	164.25	m^3/min
Fan power input	<i>P</i>	41.59	W
Service value	SV	3.95	$(m^3/min)/W$
Standby power consumption	PSB	0.37	W
Seasonal electricity consumption	Q	13.72	kWh/a
Fan sound power level	LWA	61.21	dB(A)
Maximum air velocity	<i>c</i>	2.57	m/seg
Measurement standard for service	Regulation N° 206/2012 IEC 60879:1986 EN 50564:2011 EN 60704-2-7:1998 EN 60704-1:2010 [Shall not appear all of these ones, but the same as the ones which are detailed in the ERP test report]		

SAFETY INSTRUCTION

Please study the instruction manual and below information carefully before installing or using this product.
Please keep this user manual for further reference

- The luminaires may only be installed by authorized and qualified technicians according the valid regulations for electrical installation.
- Maintenance of the luminaires is limited to their surfaces. During maintenance no moisture can come into contact with any areas of the terminal connections or voltage control parts.
- The electrical supply must be switched off at the outset, preferably by means of a switch in the distribution box, before any installation, maintenance or repair work is undertaken.
- Exterior lighting must not be installed during rain.
- Take account of the minimal separation distance from other objects and the room required around the fitting.
- If in any doubt, consult a professional, taking local installation requirements into account. Some countries stipulate that lighting may be installed only by registered installers.
- Clamping screws in electrical connections must be adequately tightened. This is particularly the case with 12V low voltage conductors.
- Clean with a clean, dry cloth or brush, use no solvents or abrasives. Avoid dampness on all electrical components
- Take account of all available technical information.
- Meaning of symbols:



This icon indicates the level of water-proof and dust-proof



Protection Class I: the fitting must be earthed



Protection Class II: the fitting is doubled insulated and does not require earthing



Protection Class III: the fitting is low voltage



Minimum distance from lighted objects (meters)



The type of lamp and maximum size and wattage indicated in each lighting unit must not be exceed; different items require different kind of light sources with different bulb icons



The armature is designed to work only with the indicated voltage. Different items require different working voltage.



The luminaire can be used in combination with a dimmer



The luminaire can be dimmed by wall switch



The reference light angle and light space of the luminaire



This luminaire cannot be disposed together with normal domestic waste in standard rubbish can, but you have to bring it to a staging area for electrical waste

11. Take note of the symbols when connecting wires:

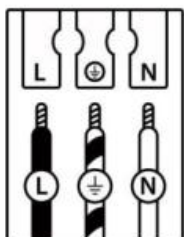

	(DE)	(GB)	(FR)	(NL)	(PL)	(NO)	(DK)
L	Stromführender Leiter	Live conductor	Conducteur	Spanning-voerende draad	Przewód prądowy	Strømførende leder	Strømførende leder
	Schutzleiter	Earth conductor	Conducteur de protection (terre)	Aardkabel	Przewód uziemiający	Jordledning	Jordledning
N	Neutralleiter	Neutral conductor	Conducteur neutre	Nulleider	Przewód zerowy	Nøytralleider	Neutralleider
	(SE)	(FI)	(IT)	(ES)	(CZ)	(PT)	(GR)
L	Strömförande ledare	Virtajohdin	Conduttore sotto tensione	Conductor de corriente	Vodič pod napětím	Condutor vivo	Ρευματοφόρος αγωγός
	Skyddsledare	Suojajohdin	Conduttore di terra	Conductor de protección	Ochranný vodič	Condutor de terra	Αγωγός γείωσης
N	Neutralledare	Nollajohdin	Conduttore neutro	Conductor neutro	Neutrální vodič	Condutor neutro	Ουδέτερος αγωγός