



SMART
HOME
LIGHTS

D | Montageanleitung • GB | Fitting instructions

833385

230V/50Hz~
1x LED-Board 24V DC/28W
nicht wechselbar / not changeable

 2,4 GHz
10 dBm

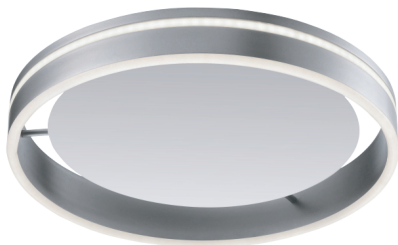

AAA, 1,5V

Inkl. Funkfernbedienung
Incl. radio remote control



28 W
3.000 lm



33 W
1.150 lm

t 20.000 h

T_K 2.700-5.000 K

 15.000 x

 <0,5 s



dimmable with rrc

4x



4x



1 | Montage / fitting

Als Deckenleuchte
As ceiling light

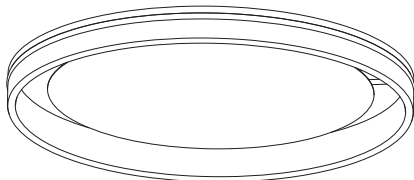
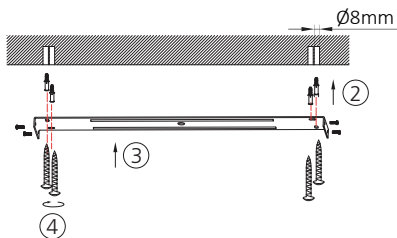
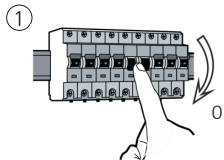

2 | Elektrischer Anschluss / electrical connection

230 Volt/50Hz-Anschluss
230 voltage/50Hz-connection

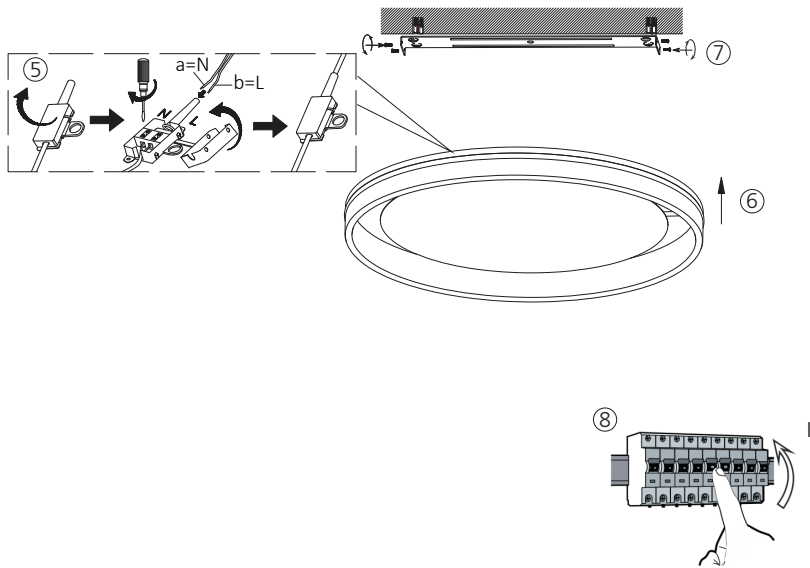

3 | Fernbedienung anlernen / teach remote control

Siehe Q-Fernbedienungsanleitung
see Q-remote control manual

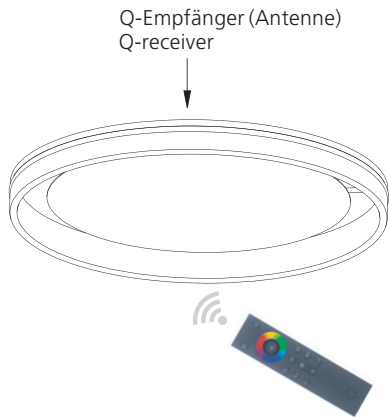

- 11 Q-Fernbedienung
anlernen
Teach Q-remote
control



- 9 Leuchte einschalten
Switch on the lamp



- 10 Bedienungsanleitung
lesen
Read instruction
manual



Reset

Rückstellen der Leuchte auf Werkseinstellung
Reset the lamp, factory new

5x on/off

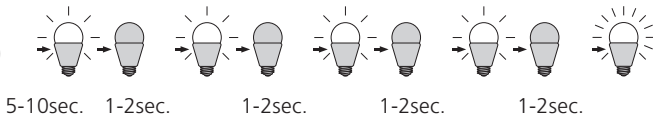

Das Gerät erfüllt die grundlegenden Anforderungen der Richtlinie 2014/53/EU (Radio Equipment Directive) des Europäischen Parlaments und des Rates der europäischen Union vom 16.04.2014 über Funkanlagen.
Die vollständige Konformitätserklärung kann bei der untenstehenden Internet-Adresse aufgerufen werden.

This device fulfils the fundamental requirements of Directive 2014/53/EU (Radio Equipment Directive) of the European Parliament and of the Council of the European Union dated 16.04.2014 on items of radio equipment.
The full declaration of conformity can be accessed at the Internet-address given below.

Paul Neuhaus

Paul Neuhaus GmbH
Olakenweg 36 · D-59457 Werl

Telefon: +49(0)2922-9721-0
Telefax: +49(0)2922-9721-9120
E-Mail: Kundenservice@neuhaus-group.de
<https://scm.paul-neuhaus.de/public/conformity/>