

Paul Neuhaus

Paul Neuhaus GmbH
Olakenweg 36 · 59457 Werl
Germany

Telefon: +49 (0) 29 22-97 21-0
Telefax: +49 (0) 29 22-97 21-9120
E-mail: info@neuhaus-group.de
<https://scm.paul-neuhaus.de/public/conformity/>



D | Montageanleitung GB | Fitting instructions

- DE** Dieses Produkt enthält eine Lichtquelle der Energieeffizienzklasse <F>.
- GB** This product contains a light source of energy efficiency class <F>.
- FR** Ce produit comprend une source de lumière de classe d'efficacité énergétique <F>.
- BG** Продуктът съдържа източник на светлина с клас на енергийна ефективност <F>.
- CZ** Tento výrobek obsahuje světelný zdroj třídy energetické účinnosti <F>.
- DK** Dette produkt indeholder en lyskilde af energieeffektklasse <F>.
- EL** Αυτό το προϊόν περιέχει πηγή φωτός της τάξης ενεργειακής απόδοσης <F>.
- ES** Este producto contiene una fuente de luz de la clase de eficiencia energética <F>.
- ET** See toode sisaldab valgusallikat energiatõhusklassiga <F>.
- FI** Tämä tuote sisältää energiatehokkuusluokan <F> valonlähteen.
- HR** Ovak proizvod sadrži izvor svjetlosti energetskog razreda <F>.
- HU** Ez a termék <F> energiahatákonysági osztályba tartozó fényforrást tartalmaz.
- IT** Questo prodotto contiene una sorgente luminosa della classe di efficienza energetica <F>.
- LT** Šis produktas yra su šviesos šaltiniu, kurio energinio efektyvumo klasė yra <F>.
- LV** Šis izstrādājums satur gaismas avotu, kas atbilst energoefektivitātes klasei <F>.
- NL** Dit product bevat een lichtbron van energie-efficiëntieklasse <F>.
- NO** Dette produktet inneholder en lyskilde i energieffektivitetsklasse <F>.
- PL** Produkt ten zawiera źródło światła o klasie efektywności energetycznej <F>.
- PT** Este produto contém uma fonte de luz da classe de eficiência energética <F>.
- RO** Acest produs conține o sursă de lumină din clasa de eficiență energetică <F>.
- RU** Данное изделие содержит источник света класса энергоэффективности <F>.
- SK** Tento výrobok obsahuje zdroj svetla triedy energetickej efektivity <F>.
- SL** Ta izdelek vsebuje svetlobni vir razreda energijske učinkovitosti <F>.
- SR** Ovak proizvod sadrži izvor svetlosti energetske klase <F>.
- SV** Denna produkt innehåller en ljuskälla i energieffektivitetsklass <F>.
- TR** Bu ürün, enerji verimliliği sınıfına sahip bir ışık kaynağı içerir <F>.

833604

230V / 50Hz~
1x LED-Board 55V DC / 58W
nicht wechselbar / not changeable

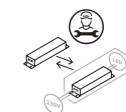
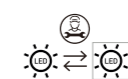
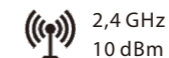

	58 W
	7.000 lm
	65 W
	2.600 lm
	LED-Board
t	20.000 h
Tk	2.700-5.000 K
	15.000 x
	<0,5 s

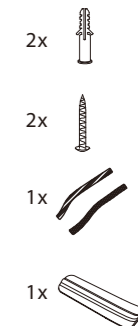

Inkl. IR-Fernbedienung
Incl. IR remote control



1 | Montage / fitting

als Pendelleuchte
as pendant light

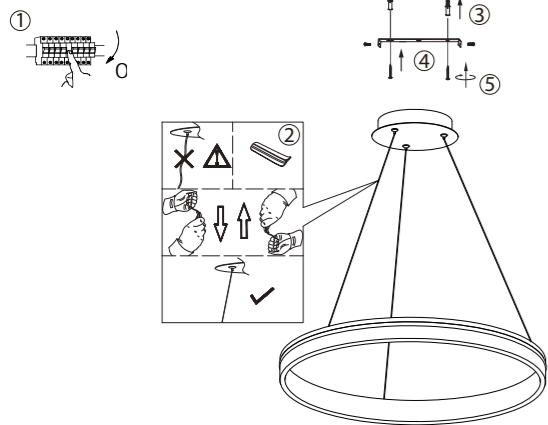

2 | Elektrischer Anschluss / electrical connection

230 Volt / 50 Hz-Anschluss
230 voltage / 50Hz - connection

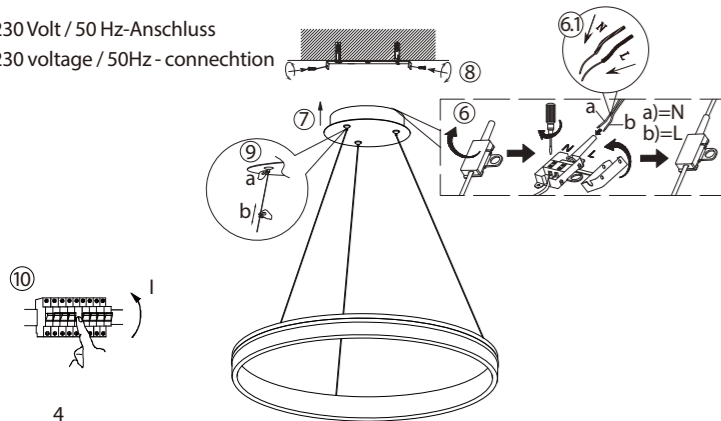

3 | Fernbedienung anlernen / teach remote control

Siehe Q-Fernbedienungsanleitung
See Q-remote control manual

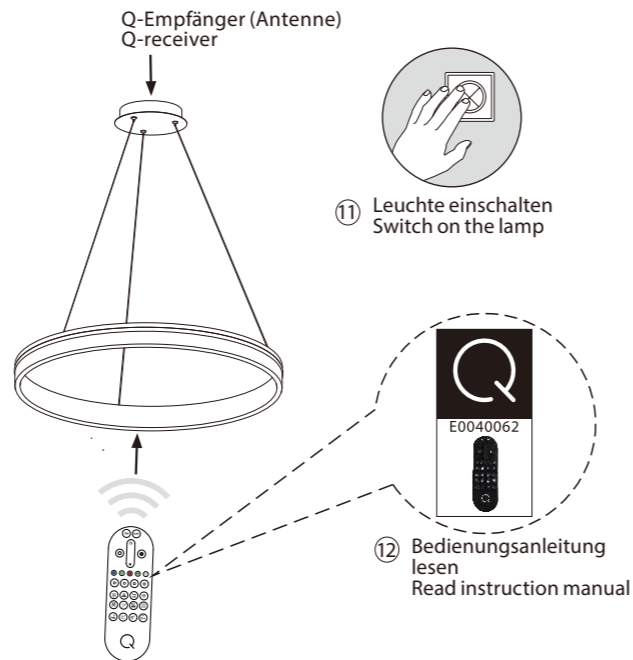

! Reset

Zur Einbindung in ein ZigBee Netzwerk, stellen Sie die
Leuchte auf Werkseinstellung zurück.

To integrate the lamp into a ZigBee network, reset the
lamp to the factory setting.

