

# INSTRUCTION MANUAL

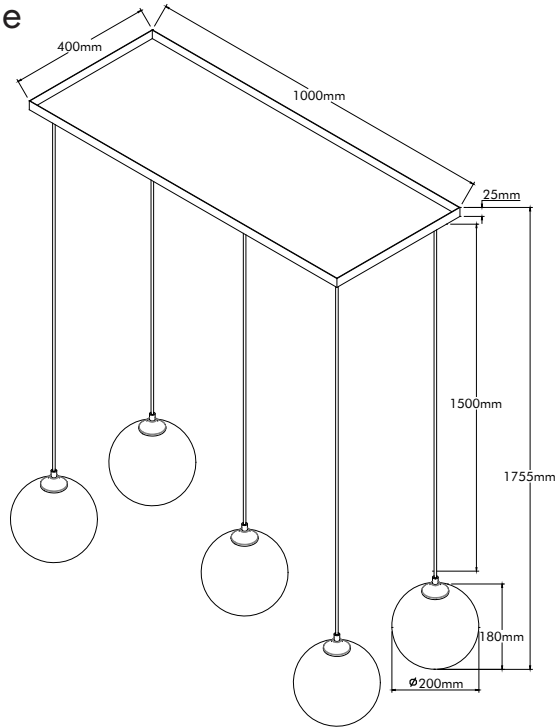

Wallace HL 5 Black Smoke  
105488



INPUT: AC220-240V

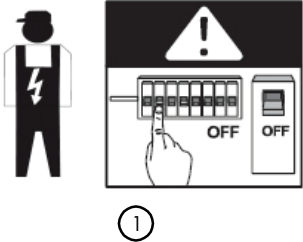

①

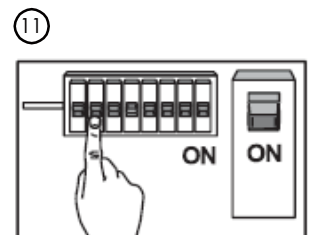
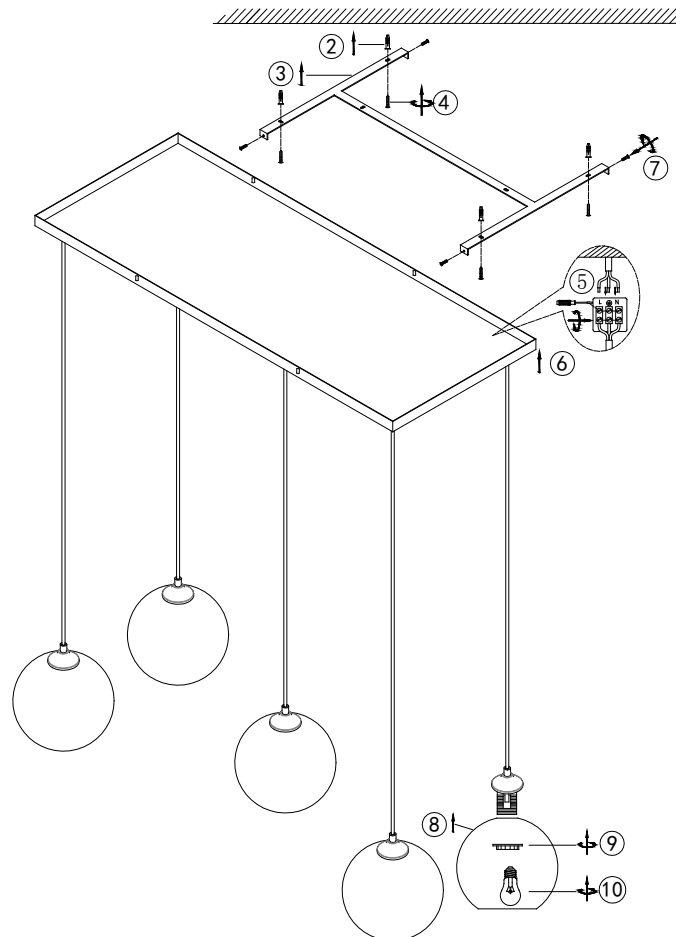

⑪

**FittinQ B.V.**

Smaragdweg 52, 5527 LB Hapert, The Netherlands  
www.qazqa.nl

QAZQA