

# INSTRUCTION MANUAL

Vifte Fan

102706/102707

CCT dim(3500-2700-3000K) with night light function



1x30W  
LED

220-240V~  
50Hz

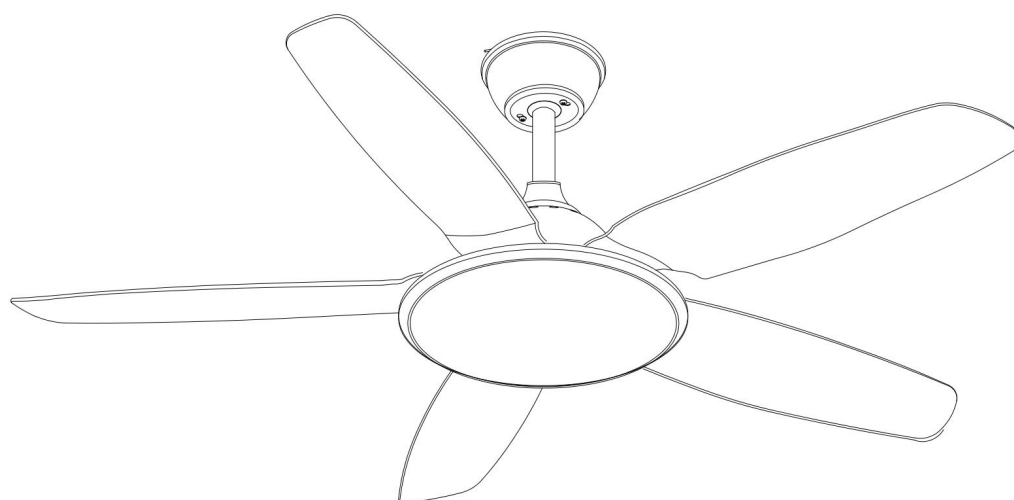

This item contains  
changeable LED

2700	M
30	W
3500/2700/3000	K
>80	CRI
17000	H

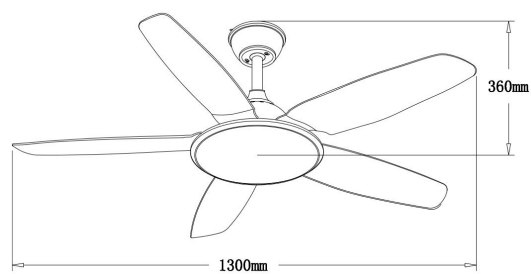

# 1. Warning symbols

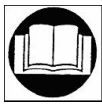

Read the instructions



Caution



Lamp

## 2. General Safety Instructions



Read this instruction manual thoroughly before using the appliance and save it for future reference and if necessary pass the instruction manual on to a third party.

**WARNING:** When using electrical appliance, basic safety precautions should always be followed to reduce the risk of fire, electrical shock and personal injury.

### 1) General

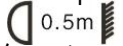
- Before carrying out any work on the fan, disconnect it from the electrical supply!
- Check if the electrical specifications of this appliance are compatible with your installation. The supplier accepts no responsibility for any physical injury or material damage resulting from incorrect use or installation of this fan. If you have the slightest doubt, please contact electrician.
- Unauthorized use and technical modifications to the appliance can lead to danger to life and health.
- This appliance can be used by children aged from 8 years and above and persons with reduced physical, sensory or mental capabilities or lack of experience and knowledge if they have been given supervision or instruction concerning use of the appliance in a safe way and understand the hazards involved. Children shall not play with the appliance. Cleaning and user maintenance shall not be made by children without supervision
- Children should be supervised to ensure that they do not play with the appliance.
- This appliance is for indoor use only.
- Means for disconnection must be incorporated in the fixed wiring in accordance with the wiring rules.
- Never install the appliance in a moist or wet room.
- Be careful when working near the rotating blades. The fan should be installed at least a height of 2.3m
- Before pushing the reversible slide switch, it is necessary to stop the action of the blades by turning off the fan
- Don't place your arm or other object in the path of the blades, when the fan is operating.
-  Always maintain the minimum distance between the lamp and any inflammable material (curtains, wall etc), as indicated on the pictogram
- Means for all poles disconnection having a contact separation that provide full disconnection under over voltage category III conditions must be incorporated in the fixed wiring in accordance with national wiring rules.
- Power supply wire from ceiling needs 1.5 sq mm wire
- Regarding the method of the cable connection , how to assembly and the bulb type reference of a luminaire, thanks to refer to the section "INSTALLATION"
- Warning: Before obtaining access to terminals, all supply circuits must be disconnected.  
  
"5. Appliance specification".
- Warning: Before obtaining access to terminals, all supply circuits must be disconnected.

## 2. Electrical safety

The appliance should be installed by authorized electrician only acc. to national wiring rules.

## 3. Specific Safety Rules

The fan is to be installed so that the blades are more than 2.3 m above the floor

## 4. Environmental protection

### CAUTION!

Electrical products must not be thrown out with domestic waste. They must be taken to a communal collecting point for environmentally friendly disposal in accordance with local regulations. Contact your local authorities or stockist for advice on recycling. The packaging material is recyclable. Dispose of the packaging in an environmentally friendly manner and make it available for the recyclable material collection-service.



## 5. Appliance specifications

TECHNICAL CHARACTERISTICS	
Rated voltage	220-240 V
Rated frequency	50 Hz
Rated wattage	40 W
Bulb rating	1x30W. LED
Ambient operating temperature	25 °C
Protection class	I
IP number	IPX0
Protective shields	N/A

## 6. The ceiling fan (element)

### PARTS DESCRIPTION

1. Safe steel wire
2. J hook (For temporary hang up the fan when wiring connection)
3. Mounting bracket
4. Nuts
5. Receiver
6. Remote
7. Hanger ball
8. Down rod
9. Upper canopy
10. Screws
11. Yoke cover
12. Cross pin
13. Cotter pin
14. Screws
15. Motor Housing
16. Screws
17. Motor
18. Light Kit fixing bracket
19. LED light plate
20. Screws
21. Blades
22. LED light kit
23. Shade

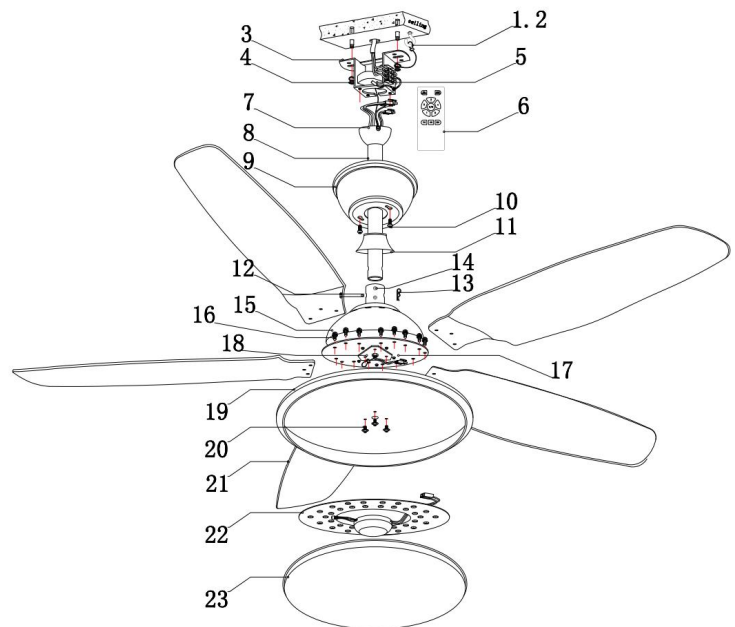

## 7. Installation of the ceiling fan

1. Insert down rod over upper canopy, then insert the cross pin over yoke & Cotter pin and fasten the screws which fix the down rod (Fig 1)
2. Install the mounting plate by screws (Fig.2)
3. Loose the screw from motor.(Fig 3)
4. Install the blade on the motor by Screws.(Fig.4)
5. Make sure the fan is disconnected from the electrical supply and carefully insert the fan into the Mounting bracket. Rotate the fan until the notch of the hanger ball engages the pin of the mounting bracket. Then, firmly fix the screws.(Fig5)
6. Assembly the LED light plate to the light kit fixing bracket by the screws and connect the LED light kit by male & female plug. Insert the remote control receiver on the mounting bracket. Connect the motor wires, LED light wires and receiver's power wires to the receiver by male & female plug. Also, connect the ground wire by male & female plug. Then connect the power supply with the fan.(Fig6)
7. Assembly the shade to the light plate and assembly the upper canopy to the mounting bracket. Both rotate clockwise when assembling.(Fig 7)
8. Now, the fan is completed.(Fig 8)

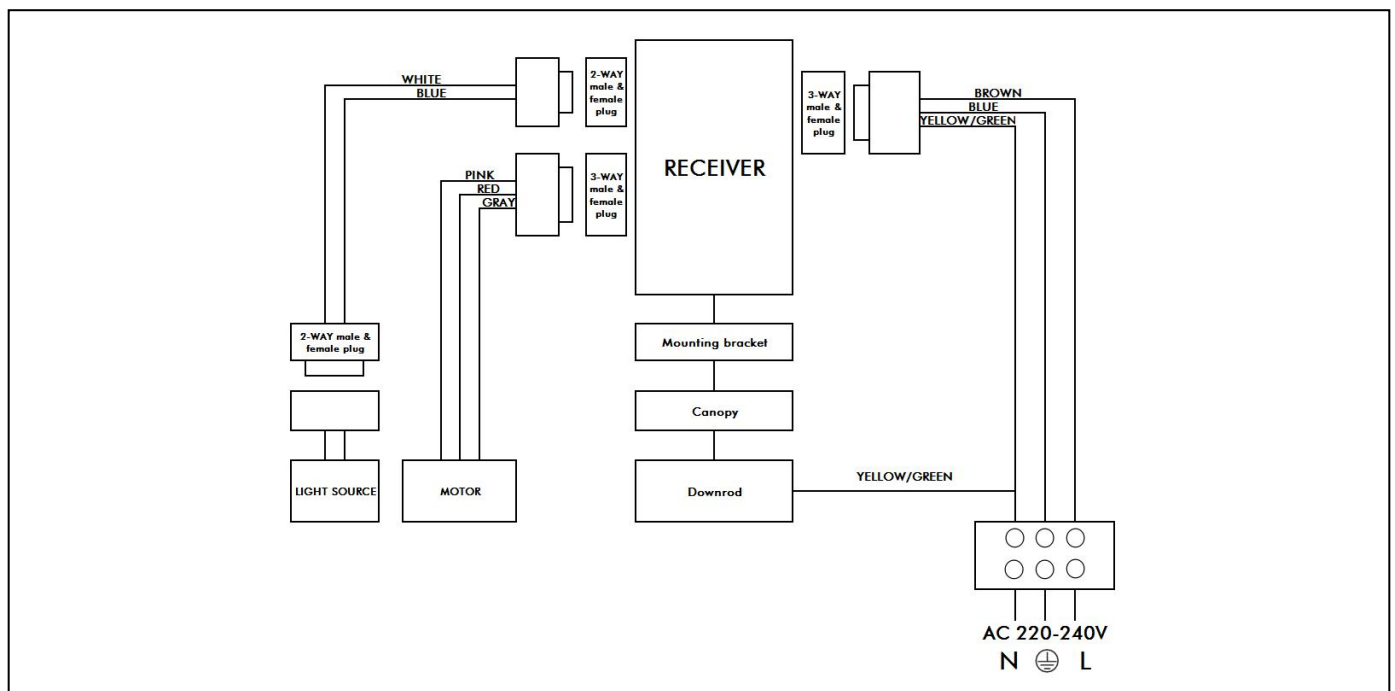
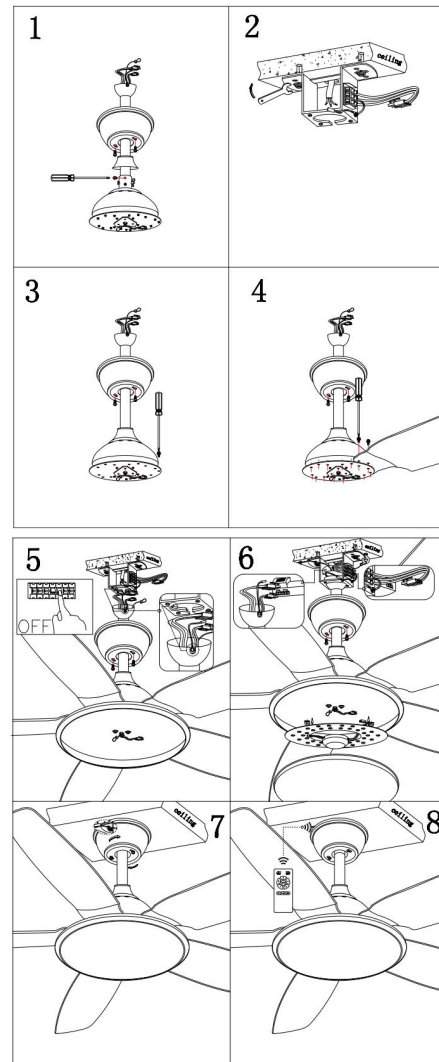

If the fan or light kit is PARTIALLY pre-assembled, you can skip the assembly procedures to next step

## 8. How to use

- Direction switch on the fan 's remote.(FORWARD and REVERSE switch)
- Down for summer make the air movement directly from ceiling.
- UP for winter, to circulate the warm air generated by heater to floor.



## 9. Remote Control

This ceiling fan can be installed with remote control, but make sure you know how to install the device in safe way or consult licensed electrician

Warranty may be affected if you install the improper remote control or install it in improper way

## 10. Disconnect from mains before maintenance or cleaning.

Do not use a wet sponge to clean the appliance.

1. Before conducting any cleaning or maintenance work, disconnect the lamp from the electrical supply and wait until it cools down
2. No abrasive products, solvents, detergent or any other liquid may be used to clean the fan or lamp
3. Be sure the power is off when you clean the fan
4. Don't clean the motor, switch house and other electric parts of the fan with water in order to avoid short circuit

## 11. Trouble shooting

TROUBLE	PROBABLE CAUSES	SUGGESTED REMEDY
1. Fan will not start	A/ Fuse or circuit breaker blown. B/ Loose power line connections to the fan. C/ Speed controller not in correct position.	A/ Check main and branch circuit fuses or circuit breakers. B/ Check line wire connections to fan C/ Check speed controller's position.
2. Fan sound noisy	A/ Top canopy touching ceiling. B/ Loose fan blade screws. C/ Ceiling fan not secured against ceiling. D/ Incorrect speed controller.	A/ Lower Canopy from ceiling to ensure minimum 3 mm clearance. B/ Re-tighten all screws on fan blades but never over-tighten. C/ Re-tighten all screws in the hanging bracket or plate. D/ Change the controller to the one supplied.
3. Mechanical Noise	A/ Allow at least for 8 hours settling-in period.	
4. Fan Wobbles	A/ Fan blades are not horizontal to ceiling. B/ Blade screws are loose.	A/ Measure from ceiling to tip of blades, then rotate fan so all blades are checked for equal height from ceiling (not adjustments may be made by slight pressure up or down on blade holders). Make sure all screws are securely fastened.

### DYNAMIC BLADE BALANCE KIT

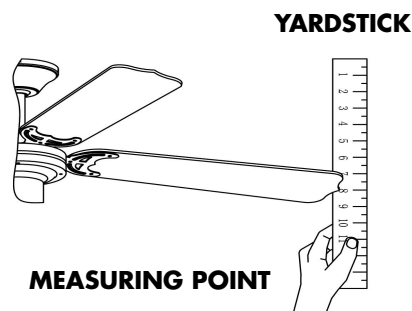

## PREFACE

Your ceiling fan may sometimes have wobble problem when operate due to irregularity in blades or the blade holder. Also, improper assembly in the mounting system may cause some additional problem also bearing crooked. The following procedure to remedy such problem is strongly recommended by us from our past experience in handling the wobble problem.

### Dynamic blade balancing kit for ceiling fans

1. Make sure that all blade are firmly screwed into the blade holder
2. Make sure that all blades are firmly secured the flywheel and check pitch of blade holders all must be the same
3. By looking up the fan from below, check and be certain that none of the blade holders are bent so that none of the blade is out of position. A correction can be made by very gently bending the blade holder back into position
4. By the simple use of a household yardstick blade tracking can be checked, out the yardstick up against the ceiling vertically and even with the outside leading edge of a blade. Note the distance of the edges of the blade to t he ceiling; carefully turn the blade slowly by hand to check the remaining blades. If blade is not in alignment, the blade holder may be gently bent up or down to be in line with the other blades

**If by following all the steps and the wobble problem is not solved, a dynamic balancing need to be done by the use of the balancing kit. Follow the procedure listed below:**

- Turn the fan on and adjust the speed control (usually high speed) setting to the speed, which creates to greatest wobble.
- Turn the fan off; select on blade place the balance clip on it. Halfway between the blade holder and the blade up on the rear edge of the blade.
- Turn the fan on, watch to see of the wobble is improved or worse. Then, turn the fan off again and move the clip to another blade and test again. Repeat this process with all blades and then note that blade which is the most improved.
- Move the clip back to the blade, which showed the most improvement. Move the clip inward and outward on this blade and operate t he fan to find the position where the clip gives the most improvement
- Next remove the clip and install a balancing weight to the top of the blade along the centerline near the point where the clip was positioned.

**Caution: stay clear of the blades if the clip for any reason is not secured, injury could result**

## 12. Others

Have your product repaired by a qualified person

This electric product is in accordance with the relevant safety requirements. Repairs should only be carried out by qualified persons using original spare parts; otherwise this may result in considerable danger to the user. This appliance can be used by children aged from 8 years and above if they have been given supervision or instruction concerning use of the appliance in a safe way and if they understand the hazards involved. Cleaning and user maintenance shall not be made by children unless they are older than 8 and supervised. Keep the appliance and its cord out of reach of children aged less than 8 years.

Please contact the store which you bought the product for after sale services if **question**

This appliance can be used by children aged from 8 years and above if they have been given supervision or instruction concerning use of the appliance in a safe way and if they understand the hazards involved. Cleaning and user maintenance shall not be made by children unless they are older than 8 and supervised. Keep the appliance and its cord out of reach of children aged less than 8 years.

Appliances can be used by persons with reduced physical, sensory or mental capabilities or lack of experience and knowledge if they have been given supervision or instruction concerning use of the appliance in a safe way and understand the hazards involved. Children shall not play with the appliance.

Please contact the store which you bought the product for after sale services if question

Information requirements regarding the eco-design			
Description	Symbol	Value	Unit
Maximum fan flow rate	<i>F</i>	64.16	<i>m<sup>3</sup>/min</i>
Fan power input	<i>P</i>	43.50	<i>W</i>
Service value	<i>SV</i>	1.47	<i>(m<sup>3</sup>/min)/W</i>
Standby power consumption	<i>PSB</i>	0.0	<i>W</i>
Seasonal electricity consumption	<i>Q</i>	13.92	<i>kWh/a</i>
Fan sound power level	<i>LWA</i>	43.50	<i>dB(A)</i>
Maximum air velocity	<i>c</i>	1.42	<i>m/seg</i>
Measurement standard for service	Regulation N° 206/2012 IEC 60879:1986 EN 50564:2011 EN 60704-2-7:1998 EN 60704-1:2010 [Shall not appear all of these ones, but the same as the ones which are detailed in the ERP test report]		















# SAFETY INSTRUCTION

**Please study the instruction manual and below information carefully before installing or using this product. Please keep this user manual for further reference**

1. The luminaires may only be installed by authorized and qualified technicians according the valid regulations for electrical installation.
2. Maintenance of the luminaires is limited to their surfaces. During maintenance no moisture can come into contact with any areas of the terminal connections or voltage control parts.
3. The electrical supply must be switched off at the outset, preferably by means of a switch in the distribution box, before any installation, maintenance or repair work is undertaken.
4. Exterior lighting must not be installed during rain.
5. Take account of the minimal separation distance from other objects and the room required around the fitting.
6. If in any doubt, consult a professional, taking local installation requirements into account. Some countries stipulate that lighting may be installed only by registered installers.
7. Clamping screws in electrical connections must be adequately tightened. This is particularly the case with 12V low voltage conductors.
8. When replacing a halogen lamp, wait for it to cool, for a minimum of 5 minutes.
9. Clean with a clean, dry cloth or brush, use no solvents or abrasives. Avoid dampness on all electrical components
10. Take account of all available technical information.
11. Take note of the symbols when connecting wires:

**N =Neutral    L =Live     =Earth**

12. Meaning of symbols:

-  For indoor use only, where direct contact with water is impossible
-  This icon indicates the level of water-proof and dust-proof
-  Protection Class I: the fitting must be earthed
-  Protection Class II: the fitting is doubled insulated and does not require earthing
-  Protection Class III: the fitting is low voltage
-  Minimum distance from lighted objects (meters)
-  Only the self-shielded halogen lamp should be used with the luminaire
-  Strip the wire to the indicated length (mm); different items require different length
-  Connect using the specified cable; different items require different cables
-  The type of lamp and maximum size and wattage indicated in each lighting unit must not be exceed; different items require different kind of light sources with different bulb icons
-  The armature is designed to work only with the indicated voltage. Different items require different working voltage.
-  The luminaire can be used in combination with a dimmer
-  The reference light angle and light space of the luminaire
-  This luminaire cannot be disposed together with normal domestic waste in standard rubbish can, but you have to bring it to a staging area for electrical waste